



"CADDIE TO THE GOLF INDUSTRY"

# 2023 Catalogue

Bag Tags	Custom X Catalogue	Tee Deck Accessories	79-83
Ball Markers	44-45, Custom X Catalogue	Towels	34-39, 84
Cart Accessories	60	Tees	27-33
Cleats	25-26	Turf Care Accessories	116-120
Gloves	40	Turf & Hitting Strips & Mats	71-75
Club Repair Supplies	65-66	Umbrellas	54-55
Course Marking	94-95	Wallets, Shoe Bags	46-52
Custom X	Custom X Catalogue		
Divot Mix Bottles & Storage	Recycled Plastics		
Divot Tools	42-43, Custom X Catalogue		
Facility Furnishings	Recycled Plastics Catalogue		
Greens Covers	117		
Headcovers	Custom X Catalogue		
Health & Suncare	22-24		
Hitting Nets	13, 72, 74		
Merchandise Bags	54		
Mini Golf Supplies	61		
Multimats	114-115		
Netting	71, 74		
Night Golf	56-57		
Pencils	58		
Poles, Cups & Flags	102-110		
Practice Green	85-87		
Proximity Markers & Cards	59		
Rakes	91		
Range Accessories	98-101		
Range Ball Baskets & Storage	76		
Range Finders & Batteries	19-21		
Re-Gripping Supplies	62-64		
Retail Accessories	6-18		
Rubber Tees & Stackers	77		
Scorecards	58		
Signage	67-69, Port City Catalogue		
Spike Cleaners	101, Recycled Catalogue		



# BETTINARDI®



EXCLUSIVELY DISTRIBUTED BY



Contact our Sales Rep for more info

# NOW OFFERING

## AIR MILES® REWARD MILES™

**GOLF**  
SUPPLY HOUSE



Collect  
**AIR MILES®**  
**REWARD MILES™**

**ON EVERY  
PURCHASE\***



**AIR MILES.**

®™ TRADEMARKS OF AM ROYALTIES LIMITED PARTNERSHIP USED UNDER LICENSE BY LOYALTYONE, CO. AND GOLF SUPPLY HOUSE LTD

\*Base Offer of 1 Mile for every \$40 spent, excluding tax. No limitations on use. Please allow up to 2-3 weeks from the time of purchase for the Miles to be posted to your collector account.

<https://shopgsh.myshopify.com/>

**EVNROLL**®  
PUTTERS  
CANADA



**EXCLUSIVELY DISTRIBUTED BY**



Contact our Sales Rep for more info

- **26" by 126"** overall size
- **Foam wedge** goes underneath the mat to act as a slight backstop.
- **Dashed line** is 17" behind 3 ft and 6 ft holes to help learn optimum putting speed.
- **3', 6', and 9'** putts
- **Single marks** on edges every 1 ft.
- **Double markings** every 3 ft for mastering consistent step length.
- **\*T\* line** at each distance to help square putter face alignment.



Comes with 1 Foam Wedge Used for Ball Return



Non-Slip Bottom



### Pelz Player Putting Mat

The first ever Pelz Putting Mat exclusively from Catalyst Golf! Teaches golfers to be experts in the scoring zone of 9' and in. Includes drills and competitive games Dave uses with Tour players and in his Pelz Scoring Schools. 10.5' x 2.2' with TPR backing prevents slipping and curling.

**CGPELZMAT**



Use Reducers to Increase the Difficulty Level

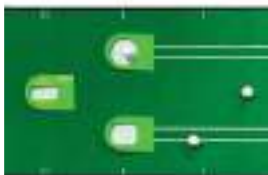

### Pelz Player Putting Cup

- \* The Putting Cup set includes two putting cups and instructions written by Dave Pelz based on coaching tour players.
- \* Two cups and two sets of removable hole reducers challenge the best putters.
- \* For use indoors and outdoors.

**CGPELZPC-PKGD**

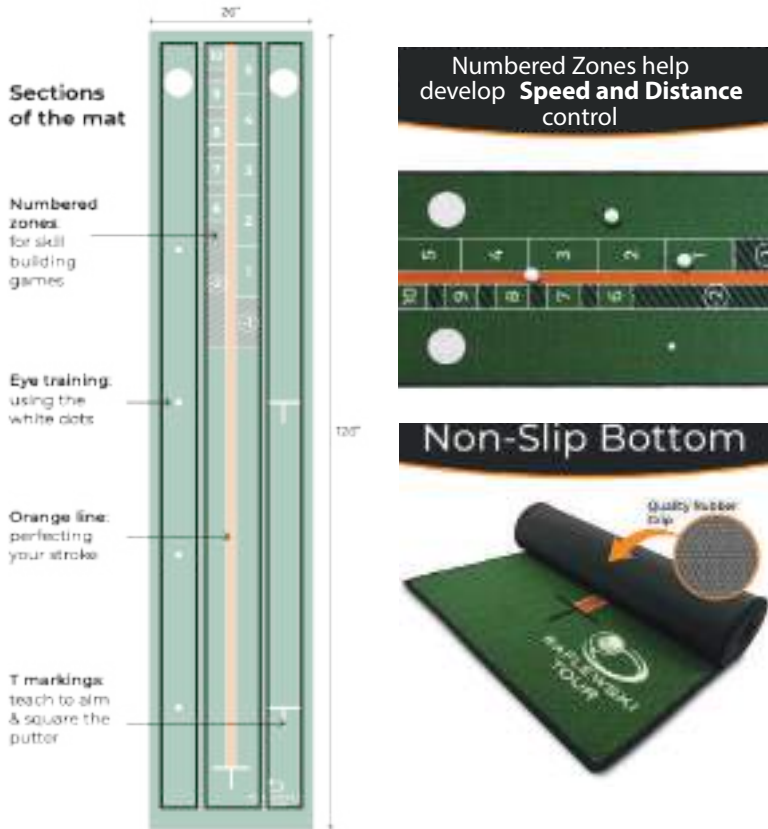

**RAFLEWSKI TOUR**  
BY GARETH RAFLEWSKI

Gareth Raflewski is a PGA Canada Teacher of the Year and coaches over 30 Tour players on the PGA and LPGA Tours including the last three years world champions on the LPGA Tour. His coaching sessions on the professional tours include training aids and many tour players carry these products in their tour bags.



**Raflewski Tour Putting Mat**

The Raflewski Putting Mat includes drills and learning techniques Gareth uses with Tour players and in his international golf schools. Improves alignment, eye training, putting stroke and speed control. 10.5' x 2' with TPR backing prevents slipping and curling.

**CGRAFMAT**

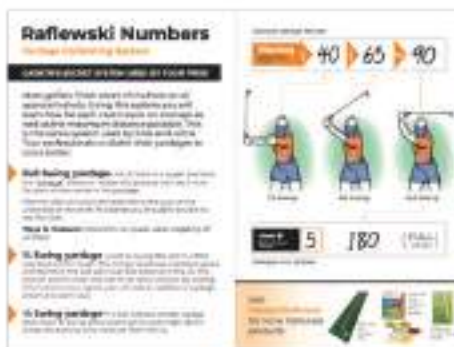

**Raflewski Numbers**

Catalyst Golf Exclusive! Raflewski Numbers sticker sets allow you to record your yardages for each of your wedges. Know your numbers! Each pack includes 5 sets of stickers and a free Sharpie Mini.

**CGRAFNBR**



### Raflewski Tour Putting Ruler II

- \* One Ruler with double sided graphics included.
- \* Great training aid to teach putter path, backswing length, and putting line
- \* This is our best selling training aid with orders shipped worldwide.

**CGRAFRULER-PKGD**

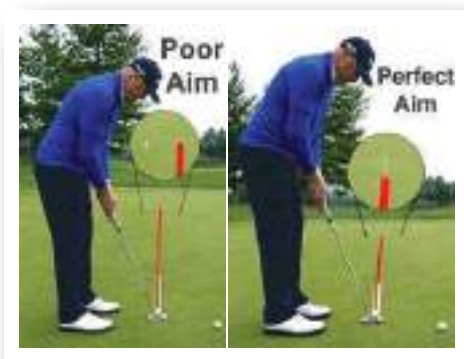

### Raflewski Tour Putting Program with Putting Discs & Dots

- \* Four Putting Discs and ten Putting Dots with instructions by Tour Coach Gareth Raflewski included.
- \* Used together with Gareth's tour level instructions, golfers now have a putting program that teaches the fundamentals of green reading.

**CGRAFPTPRG-PKGD**





# PuttOUT



- LIME
- STONE
- MINT
- CORAL

## PuttOUT Pressure Putt Trainer

- \* PuttOUT have taken their original pressure Putt trainer to another level with the following features:
- \* Multiple targets to vary practice sessions.
- \* Triple, forward aim points, central, left and right
- \* Micro target is now highly visible when open & closed
- \* The high level, elastomer, alignment sick support provides an additional aim point for longer putts.
- \* Increased profile branding with spun aluminum badge

SCPUT/PRE/



## PuttOUT Pressure Putt Trainer Platinum

- \* Special Edition PuttOUT Platinum Pressure Putt Trainer
- \* Made from polished alloy & rubber, finished with a high quality enamel badge in a commemorative box.

SCPUT/PLAT



## PuttOUT Devil Ball

- \* Work on square putter delivery indoors and out
- \* 3 custom shaped balls
- \* Engrain a perfectly square putting stroke
- \* Consistent putting stroke will roll the ball straight & true
- \* Open or closed putter will spin the ball off line
- \* Take your putting to a new level.

SCPUT/DEVIL

# PuttOUT



## Slim Putting Mat Green

- \* A portable, compact putting mat that you can take anywhere
- \* 25 cm x 240 cm rolls out flat everytime
- \* Simple PuttOUT alignment marking

SCPUT/MAT/MINI



## Medium Putting Mat

- \* A portable, compact putting mat that you can take anywhere
- \* 50 cm x 240 cm rolls out flat everytime
- \* Simple PuttOUT alignment marking

SCPUT/MAT/GRY

SCPUT/MAT/GRN



## Large Putting Mat Green

- \* A portable, compact putting mat that you can take anywhere
- \* 67 cm x 360 cm rolls out flat everytime
- \* Simple PuttOUT alignment marking
- \* Additional targets on left side of mat encourages practice variation

SCPUT/MAT/LRG

# PuttOUT



## PuttOUT Putting Mirror and Gate Set

- \* Work Alignment and eye position
- \* Steel backed mirror has magnetic guides to set up drills to work on consistent putter path
- \* Spiked rubber base secure the mirror on all surfaces

SCPUT/M/RED/GREY



## PuttOUT Compact Mirror

- \* A great size to fit into your golf bag and check your positions before you go out to play.
- \* Shatterproof mirror
- \* Non scratch alignment graphics
- \* Rubber base with spikes to secure the mirror to putting greens or PuttOUT Putting Mats
- \* Ball location in base
- \* Protective Bag

SCPUT/M/MINI



# PuttOUT



## PuttOUT Pro Putting Gates

- \* Refine your putting stroke indoors and out
- \* 3 sizes of gates, small 50mm, medium 60 mm & large 70 mm
- \* Powder coated steel gates
- \* Weighted, spiked feet to use anywhere
- \* Protective bag

SCPUT/GATE



## PuttOUT Putting Plane + Alignment Stick Set

- \* Multiple putting drills with the PuttOUT Putting Plane & Alignment sticks
- \* Alignment Sticks
- \* Putting Rails
- \* Adjustable Putting Plane
- \* Putting Gates
- \* Putting Line

SCPUT/ALIGN





\* Shown Range with included 3 chipping targets

\* Shown Deluxe with included 4 chipping targets

### Quick-Up - Range Hitting Nets

- \* Best household practice net available!
- \* It's fast easy set-up and convenient storage and mobility makes it an ideal anytime/anywhere practice range
- \* Pull draw sting to pop net up in seconds!
- \* Powerful and sturdy
- \* Accepts all shots from drivers through wedges
- \* Includes hitting screen, practice target, turf strip, tie downs, and a carrying case
- \* Comes in two sizes

**QUP001**

**Range: 5'L x 8' W x 5'H**

**QUP002**

**Range Deluxe: 5'L x 10' W x 7'H**



### Plastic Practice Balls w/ Plastic Bucket

- \* White/Yellow
- \* Allows for practice anywhere
- \* Lightweight design for limited distance
- \* 48 ct

**PSPAPB6048**



### Foam Practice Balls w/ Metal Bucket

- \* Orange, Green, Blue and Yellow
- \* Great for Practice
- \* Popular Retail Item
- \* Indoor/Outdoor Use
- \* 42 ct

**PSPAFBM6042**



### Pride Sports Golf Practice Balls

- \* Maintains characteristics of a true golf ball
- \* Real ball feel
- \* Sold in 12 packs

**PSPAWB6012**

**White Wiffle Balls**

**PSPAWB5612**

**Orange Wiffle Balls**

**PSPAFB6012**

**Yellow Foam Practice Balls**



### Pride Sports 24" Round Chipping Net

- \* Small inner target to hone your skills.
- \* Collapsible design for easy storage and set up In a snap.
- \* 24" in diameter.

**PSPACN301**



### Accufli Max Soft

The Max Soft produces optimal initial ball velocity for a longer ball flight. It feels soft at impact and its fluorescent matte finish is vivid and eye-catching.

- \* Large High Energy Soft Core
- \* Soft Dupont Ionomer Cover
- \* Aerodynamic Dimple Design
- \* Semi Transparent Fluorescent Matte Finish



### Accufli Max Soft Mix

- \* Large high velocity and low spin core maximize ball speed off the club face.
- \* 312 oversized aerodynamic dimple design for ball lift and carry distance .
- \* Dupont cut proof ionomer cover for exceptional feel and durability .

**AC01015** Glossy White 12pk

**AC01021** Teal, Green, Orange and Purple



### Accufli Max Distance Ball

Accufli Max Soft is a distance golf ball which is incredibly soft. Softening hybrid ionomer thin Cover enhances soft feel and soft landing. Ultra-low compression energy core produces fast ball speed and increases shot accuracy. Aerodynamic dimple design reduces drag and increases total distance. Outstanding visibility and soft feel.

**AC01024** White Glossy 12pk

### Max Soft Counter Ball Display

Acrylic Display Container  
Max Soft Mix Case 36 pc  
(6X colors red, pink, purple, teal, orange, green)

**AC01014**

### Accufli Swing Balance Speed Ball

The new Accufli Swing-Balance Speed Ball is made from 230g of silicone rubber. Regular use will help improve speed and flexibility. To use, simply click it onto the shaft moving it closer to the head for flexibility training, or closer to the grip for speed training. Compact in size, Speed Ball can also be carried to the course and used to warm up before your round.

**AC02018**

Heavier + ← — Lighter

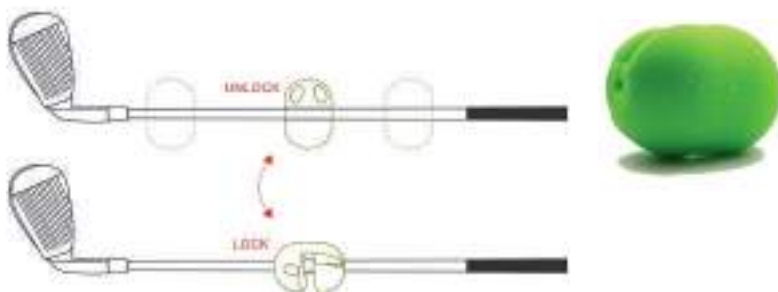



### Catalyst Golf Alignment Sticks

- \* Includes two 48" alignment sticks
- \* Yellow, red, lime, orange
- \* Comes with plastic carrying case
- \* Each stick has one pointed end

**Save 10% on prepacks of 16 sets**

**KMALIGN**



### Pride Sports Alignment Sticks

- Includes two collapsible 48" yellow alignment sticks
- Each stick folds into four sections for easy packing

**PSPAAS301Y**



### Compact 10' Ball Retriever

- \* Ergonomic sure-grip handle
- \* Extends up to 10'
- \* High quality aluminum alloy
- \* Visible orange colour

**PSPACBR301**

### Player Select 9' Super-Lite Retriever

- \* Compact at only 19" long
- \* Weighs only 7 ounces
- \* High-Vis head traps ball
- \* Push button locks and unlocks shaft

**PROMBR300**



### Exploder Ball

Explodes into a cloud of smoke-like powder upon impact

**PRDBE002**



### Ka-Ching™

On-course coin game makes every shot count through the last hole. Great fun for both low and high handicappers. Includes 10 enameled metal coins and carry pouch. Add a little "Ka-Ching!" to your round.

**PRJKC001**



### Kid's Klubs

Rolling bag includes putter, iron, driver, 3 balls and two cups with flags. Perfect gift item for kids

**PRMJR008**





### Club Brush Bungie Brush

- \* Cleans clubs and shoes
- \* Clips to golf bag

**KM010222**



### Birdie Brush

- \* Compact groove cleaner fits comfortably in your pocket
- \* Magnets hold your choice of 24 mm dome logo or custom cast ball marker
- \* Colour options: Antique Brass, Gun Metal and Antique Silver

**CXGRO002**



### Terminator Brush

- \* Features dual bristles, a retractable cord, and a carabiner clip for securing to a golf bag
- \* Add your logo for \$1.00 per brush

**ES061890**



### Pride Sports Deluxe Club Brush

- \* Retractable nylon cord attaches to golf bag
- \* All purpose brush cleans any surface

**PSPACS6001**



### Hole In One Lapel Pin

- \* Antique Silver 27mm
- \* Sold in packs of 10

**140302**

## Latch It Ecosystem

Latch-It Ecosystem, powered by Catch Latch, features the most sophisticated, secure, and convenient fastening technology invented. Male dongles self-align and magnetically connect with receivers featuring an interior motion sensing dynamic lock and an additional external roto lock for added security when needed.



### Golf Cart Latch It

Never drop or lose your rangefinder again! With Rangefinder Latch-it, your rangefinder securely and conveniently attaches to your cart, bag or belt.

- \* Fast, secure, easy access anywhere on the course
- \* Motion sensing dynamic lock keeps rangefinders secure even in bumpy "off road like" conditions
- \* Dongle and receiver straps have non-slip grip pads to stay in place
- \* PGA Merchandise Show "Best New Product" in 2017 as part of the Latch-It Ecosystem
- \* Receiver dongle strap is compatible with Frogger golf bags, Bag Latch-It, and Belt Latch-It, all sold separately

**FGCL1017**



### Phone Latch It

Stop digging for your phone on the course! Attach your smart phone to golf carts for fast, easy access plus record golf swings for training.

- \* Receiver strap for carts has a non-slip grip pad to stay in place
- \* Phone cradle adjusts to fit snugly around leading smartphones
- \* Added drop security with protective covering on holder
- \* Phone cradle is compatible with Frogger golf bags, Bag Latch-It, and Belt Latch-It, all sold separately

**FGCL1005**



### Golf Bag Latch It

Attach and detach your favorite accessories to your golf bag quickly and securely with award-winning Latch-it magnetic fastening technology.

- \* Universal bag and belt clamp accessory attachment system
- \* Dongle ring allows golfers to attach accessories through their loops or grommets
- \* Dongle and Receiver magnetically attract and self-align when connecting
- \* Compatible with every accessory in the Latch-It line

**FGCL1007**



### Energizer Lithium Rangefinder Battery (3 Volt) CR2

\* Delivering long-lasting performance

**EL1CR2BP**



### Bag Bead Counter

\* Bead counter for attaching to your bag  
\* Blister packed

**KM010044**



### Softspikes Ball Alignment Tool

This Alignment Tool is the only tool that marks both sides of the ball. It features the new Putter Squareness Line for keeping the putter face square through impact, and the new Swing Path Reminder Line to help promote a proper swing path.

**PSBLM8006**



### Sharpie Mini Display Fishbowl

\* The industry standard  
\* Half the size to fit in pockets  
\* Or, cap clip easily attaches to golf bags  
\* 72 pieces per bowl

**SH010346**



**easygreen**<sup>®</sup>  
1300 Rangefinder



**Easygreen 1300 Laser Rangefinder**

Get the most accurate distance, with the EASYGREEN 1300 laser rangefinder. Which is Tour certified to give you the confidence to select the right club and get the best result.

The device is accurate to within 1- yard of distance, with a range of 5 - 1,300 yards, 400 yards to a flag. Plus features Slope Compensation Technology which compensates distance based on inclines and declines for a more accurate reading, which can be switched off for use in competition.

The device is rubber armoured, with a splashproof (IPX4) ergonomic housing

**Features**

- \* Pin Tracker with Vibration Technology
- \* Slope Compensation
- \* Accurate to 1 Yard
- \* 6X Magnification
- \* 5 - 1,300 yard Range
- \* 400 yards to flag In-view in metres or yards
- \* Splashproof - IPX4
- \* Lithium Battery CR2
- \* Dimensions: 105 x 72 x 38 mm / 4.1 x 2.8 x 1.5 inches



SCJRF/001



KEY FEATURES	EASYGREEN JOLT 1300 \$349 Retail	BUSHNELL V4 SHIFT \$449 Retail	BUSHNELL PRO X2 \$649 Retail
Slope Compensation Technology	YES	YES	YES
Rubber Armored Housing	YES	YES	YES
Waterproof	YES	NO	YES
Pin Tracker with JOLT Technology	YES	YES	YES
Accurate to a 1 yard	YES	YES	YES
Ranges 5-1,300 Yds; 450+ Yds to a Flag	YES	NO	YES
6X Magnification	YES	NO	YES
Fast Focus System	YES	YES	YES
Stable-Grip Technology	YES	YES	YES
Legal for Tournament Play	YES	YES	YES
In-view LCD display	YES	YES	YES
Multi-coated Optic System	YES	YES	YES
Premium Carry Cases	YES	YES	YES

# easygreen®

MAKING GOLF EASY



**Easygreen OLED Vision Pro**

This true OLED display gives you a higher quality reading in all light and weather conditions.

- 1000 metre range
- Accurate to 0.5 metres +/-
- True OLED red & green display
- 6x magnification
- Pin tracker technology
- Optional slope function
- Vibration feedback
- Scanning function
- IPX4 water resistant
- Lightweight (98 grams)
- Approved for competition purposes

SCJRF/002



**OLED VISION PRO**  
CRYSTAL CLEAR VISIBILITY IN ALL CONDITIONS

- 0.5 Meter Accuracy & 0.1 Meter Resolution
- Real Slope On / Off Button
- Dual Color True OLED Display System
- High 80% Light Transmittance Optics
- Red-Green LED Light Indication
- Compact Size Design

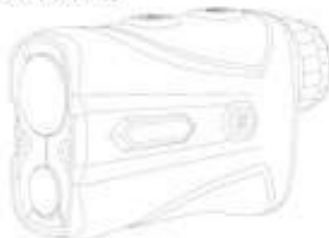

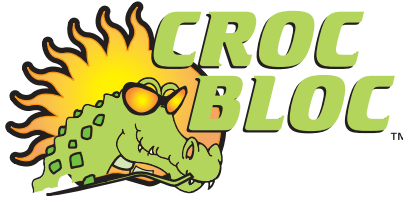

### Croc Bloc 10ml Crock Pac

- \* Enough sunscreen in a 3" x 5" packet to protect an adult wearing shorts and a golf shirt
- \* 50 packs per countertop display

**CB12310**

### Croc Bloc Insect Repellent

#### 4 oz Pump spray – Lite Duty

- \* Pump spray provides excellent coverage, mobility and portability. Just Spray and Go!
- \* 12 bottles per case

**CB12435A**

**30% DEET Liquid Spray 4 oz Pump**



#### 5.2 oz Aerosol - Heavy Duty

28.50% DEET makes it the most effective repellent against mosquitoes. This product contains three repellents. It is extremely effective against mosquitos and all biting insects including Fleas, Ticks, Black Flies, Deer Flies, Gnats, Biting Midges, NO SEE-UMS and many more ...

- \* Case of 12

**CB12435**

**28.5% deet, 5.2 oz Aerosol**



### Croc Bloc Towelettes

- \* Repels mosquitoes for up to 6 hours.
- \* 50 Towelettes w/display

**CB12402**

**Contains 10% deet.**



# KINeSYS®

## The KINeSYS Story

KINeSYS inspired from the Greek < klnesis > meaning “movement, activity”

For 20+ years KINeSYS has been synonymous with superior sun protection among athletes, active families and those with sensitive skin seeking ‘something better’.

KINeSYS sunscreen, bottles, components and packaging is proudly made in British Columbia and are 100% recyclable.



### BENEFITS

Sun protection that doesn’t impact performance - a true sport sunscreen that is easy to apply and wear

Oil-Free, clear spray that won’t clog pores - suitable for everyday use, including on face, sensitive and oily skin

Lets active skin breathe- doesn’t create the hot, heavy and greasy side effects on traditional sunscreen

Gentle and nourishing on the skin - Alcohol free, hypoallergenic & enriched with Vitamin E

**Doesn’t affect grip.** The sun protection solution for golf, racket sports, ball sports, climbing and cycling - or where grip is crucial



## Application and Top Tips

### 1) Think Sweep and Wipe.

Spray using a sweeping motion and wipe over to ensure even coverage.

**Tip: Avoid spraying in one area only, the sunscreen is a liquid and will run.**

2) **Don’t spray onto the face** - spray into the hands and wipe over the face.

Feel oily? **KINeSYS DOESN’T CONTAIN OIL.**

The Alcohol-free formula means KINeSYS takes 1-2 minutes to dry. It can feel tacky to start, but be patient. KINeSYS will quickly dry to a smooth, silky finish and will not dry out the skin.



# KINeSYS®



KINeSYS Sunscreen Fragrance Free or new Mango Scent

### Fragrance Free!

Minimal effort, maximum performance! When you can't wait to get outdoors, you need a sunscreen you trust... that goes on fast. Protecting yourself with our SPF 30 Fragrance Free Spray Sunscreen is as easy as spray, swipe-over and off you go. Our highest SPF formula is super light, quick-drying and non-greasy for a better feeling on your skin; with no added fragrance for a scent-free experience.

**Fragrance Free 120ml SPF 30**

**KINSPF30-FF-120** Sold In Packs Of 6

### Mango Scent!

Protect yourself with our SPF 30 Mango Scented Spray Sunscreen, with the subtle scent of summer in our iconic blue bottle. Our oil-free formula is super light, quick-drying, and non-greasy for a better feeling on your skin; and won't get in your way of staying active...or relaxing poolside with a book.

**Mango 30ml SPF 30**

**KINSPF30-MNG-30ml** Sold In Packs Of 24

**Mango 120ml SPF 30**

**KINSPF30-MNG-120** Sold In Packs Of 6

#### Active Ingredients

Avobenzone 2.50%, Octinoxate 7.50%, Octisalate 5.00%, Octocrylene 7.50%

#### Inactive Ingredients

Bisabolol, Butyloctyl Salicylate, Cyclopentasiloxane, Diphenylsiloxy Phenyl Trimethicone, Octyl Palmitate, Tocopherols, VP/Hexadecene Copolymer

## Why Choose KINeSYS?

KINeSYS is a true performance sunscreen. What KINeSYS leave out and put into the unique formula, and how the sprays are applied, make it distinct from traditional sunscreen.

FEATURES			
Oil-free	✓	No dairy	✓ UVA/UVB Broad Spectrum ✓
Preservative-free	✓	No sulphites	✓ Pump spray sunscreen (non aerosol) ✓
Alcohol-free	✓	No colorants	✓ Water Resistant (80 min) ✓
PABA-free	✓	Antioxidant	✓ Sweat Resistant (80 min) ✓
Paraben-free	✓	Hypoallergenic	✓ Ideal for face and oily skin ✓
Gluten-free	✓	Non-Comedogenic	✓ Works well under and over make-up ✓
No nuts or nut oil	✓	Vegan	✓ Vitamin E enriched ✓
Oxybenzone-free	✓	Cruelty-free (not tested on animals)	✓ Matte, silky finish ✓





PS7064CH66



PSSPOPCLT



PSSPOPWAL



PSSPOPGON

### 3-Tier Cleat & Tee Display

Free with purchase of 24 bags of Softspikes cleats, Champ cleats, Pride Performance Plastic Tees and/or Champ FlyTees (Mix and Match)

**PS7064CH66**

### Softspikes Cleat Changing Station

Take the hassle out of cleat changing! The convenient Bulk Cleat Changing Station positions the shoe exactly where you need it. With three open shelves beneath, you can store multiple tubs of bulk cleats for easy access. The removable waste tray makes clean-up a breeze.

\* FREE with purchase of 4-400 cts or 2-800 cts or 84 bags

**PSSPOPCLT**

### 1 or 2 sided Wall Display

24 cleat bags, 12 bags 2-1/8, 24 bags 2-3/4, 24 bags 3-1/4, 3 ripper wrenches, 3 cleat kaddys, 12 ball pickups, 12 club brushes, 3 alignment sticks, 6 BW trifold towels

**PSSPOPWAL**

### Gondola Display (3-sided)

48 cleat bags, 12 bags 2-1/8, 24 bags 2-3/4, 24 bags 3-1/4, 12 pp 2-3/4, 12 pp 3-1/4, 6 ripper wrenches, 6 cleat kaddys, 12 GBAT, 12 ball pickups, 12 club brushes, 12 impact recorders, 3 alignment sticks, 24 golf towels

**PSSPOPGON**

# CHAMP

ASK YOUR SALES REP FOR THE CLEAT REPLACEMENT GUIDE



**PULSAR**



## Champ Stinger

The Stinger Scorpion cleat has three soft, anti-clogging legs for extra comfort and traction. This cleat is an all-weather performance cleat, ideal for wet conditions.



Type	Q-Lok	Fast Twist	SM Metal
<b>Bag</b>	<b>PS75630</b>	<b>PS75640</b>	<b>PS75610</b>
<b>25 Change (400 ct.)</b>	<b>PS77630</b>	<b>PS77640</b>	<b>PS77610</b>

## Pulsar

Pulsar is the most popular cleat in the industry! Pulsar golf cleats feature eight flexible legs, providing exceptional comfort. The green-friendly pads assist in grip and traction



Type	Pins	Fast Twist	SM Metal
<b>Bag</b>	<b>PS14D0T1K</b>	<b>PS14E0T2K</b>	<b>PS14A4T1K</b>
<b>25 Change (400 ct.)</b>	<b>PS14D0T1J</b>	<b>PS14E0T2J</b>	<b>PS14A4T1J</b>
<b>50 Change (800 ct.)</b>	<b>PS14D0T1N</b>	<b>PS14E0T2N</b>	<b>N/A</b>

## Softspikes Cleat Ripper™ and 2-Pin Key

The Softspikes Multi-Wrench Kit offers both the Softspikes Cleat Ripper and the Softspikes 2-prong Insertion Wrench. Now installing or changing cleats has never been easier!

**PSSSCRKF**

## Champ 2-Pin Cleat Wrench

The new Champ Two-Pin Cleat Wrench can remove and install most cleats with ease

**PSPATW**



## Champ MaxPro Wrench

The Champ MaxPro Wrench is the latest in cleat changing tools. It has a contoured, soft-touch dual density handle. The three-position ratchet for insertion makes removal of cleats simple. The MaxPro Wrench comes with two-point, six-point and eight-point bits

**PS88401**



**Pride Professional Tee System™**

	1 1/2"	FOR IRONS, HYBRIDS AND LOW PROFILE WOODS
	2 1/8"	FOR IRONS, HYBRIDS AND LOW PROFILE WOODS
	2 3/4"	FOR DRIVERS UNDER 360CC
	3 1/4"	FOR DRIVERS OVER 360CC



### PTS Wood Green Grass Bags

\* Case contains 200 bags

<b>PSPT2180275</b>	<b>2 1/8" - 25/Bag</b>
<b>PSPT2340275</b>	<b>2 3/4" - 20/Bag</b>
<b>PSPT3140275</b>	<b>3 1/4" - 15/Bag</b>



### PTS Wood Retail Bags

\* Case contains 12 bags

<b>PSPT2181275</b>	<b>2 1/8" - 120/Bag</b>
<b>PSPT2341275</b>	<b>2 3/4" - 100/Bag</b>
<b>PSPT3141275</b>	<b>3 1/4" - 75/Bag</b>



Looking for more display options see page 30

### PTS Green Grass Display

\* Free with purchase of 400 Green Grass Bags, PTS Wood, Pride Performance Plastic, or a combination

**PSPTSGGDISPLAY**

### MaxxPro "Oversized" Golf Plastic Tee

MaxxPro Oversized Plastic golf tees are engineered with a larger head to allow easier placement of the golf ball. This durable plastic golf tee has built in dimples inside the tee cup to make sure the golf ball sits high on the tee. This allows for consistent drive distances.



### MaxxPro Retail Bags - Neon Mix

\* Case contains 6 bags

<b>PSMPN23410M</b>	<b>2 3/4" - 10/Bag</b>
<b>PSMPN31410M</b>	<b>3 1/4" - 10/Bag</b>

\* MaxxPro are also available in bulk



### MaxxPro PTS Retail Bags

\* Case contains 6 bags

<b>PSMP23410</b>	<b>2 3/4" - 10/Bag</b>
<b>PSMP31410</b>	<b>3 1/4" - 10/Bag</b>



### PTS Performance Green Grass

- \* Case contains 200 bags
- \* See opposite page for display information

<b>PSEV11210</b>	<b>1 1/2" - 10/Bag orange</b>
<b>PSEV23410</b>	<b>2 3/4" - 10/Bag yellow</b>
<b>PSEV31410</b>	<b>3 1/4" - 10/Bag blue</b>

### PTS Performance Retail Packs

- \* Countertop display available on request with purchase of 24 or more packs

<b>PSEV11230</b>	<b>30 Pack - Blister of 1 1/2" Tees</b>
<b>PSEV23430</b>	<b>30 Pack - Blister of 2 3/4" Tees</b>
<b>PSEV31430</b>	<b>30 Pack - Blister of 3 1/4" Tees</b>

### Performance Combo Packs

- \* Each Combo Pack includes 40 (2 3/4" or 3 1/4") and 10 (1 1/2") Performance Golf Tees

<b>PSCPEV23450</b>	<b>50 Combo Pack - Blister of 40 (2 3/4") &amp; 10 (1 1/2")</b>
<b>PSCPEV31450</b>	<b>50 Combo Pack - Blister of 40 (3 1/4") &amp; 10 (1 1/2")</b>

### Novelty Tees

- \* Available in 2-3/4" and 3-1/4"
- \* Designs include Shamrock, Playing Cards, and \$\$\$
- \* Bags of 45 tees

<b>PSPS23445C</b>	<b>2 3/4" Playing Cards Tees</b>
<b>PSPS23445S</b>	<b>2 3/4" Shamrock Tees</b>
<b>PSPS23445M</b>	<b>2 3/4" Money Tees</b>

<b>PSPS31445C</b>	<b>3 1/4" Playing Cards Tees</b>
<b>PSPS31445S</b>	<b>3 1/4" Shamrock Tees</b>
<b>PSPS31445M</b>	<b>3 1/4" Money Tees</b>

### 4 Yards More

<b>GK024705</b>	<b>Short Tee 1 3/4" Red</b>
<b>GK024700</b>	<b>Standard Tee 2 3/4" Yellow</b>
<b>GK024710</b>	<b>Driver Tee 3 1/4" Blue</b>
<b>GK024715</b>	<b>The Extreme 4" Green</b>
<b>GK024720</b>	<b>Variety Pack 1 each size</b>
<b>GK024725</b>	<b>Hybrid 1" Irons &amp; Hybrid Clubs Purple</b>



### Zarma FLYTee Plain

\* cases of 6

SKU	Size	Colour	Tees/Pk
PS92511	1 3/4"	White	20
PS92521	2 3/4"	White	30
PS92522	2 3/4"	Yellow	30
PS92523	2 3/4"	Orange	30
PS92524	2 3/4"	Red	30
PS92526	2 3/4"	Neon Green	30
PS92527	2 3/4"	Dk Blue	30
PS92563	2 3/4"	Standard Mix	30
PS92565	2 3/4"	Neon Mix	30
PS95509	2 3/4"	Neon Pink	30
PS95513	2 3/4"	Patriot	30
PS95515	2 3/4"	Neon Blue	30
PS95528	2 3/4"	Natural	30
PS92541	3 1/4"	White	25
PS92542	3 1/4"	Yellow	25
PS92543	3 1/4"	Orange	25
PS92544	3 1/4"	Red	25
PS92546	3 1/4"	Neon Green	25
PS92564	3 1/4"	Standard Mix	25
PS92568	3 1/4"	Neon Mix	25
PS95510	3 1/4"	Neon Pink	25
PS95516	3 1/4"	Patriot	25

### Zarma FlyTee My Hite

\* cases of 6

SKU	Size	Colour	Tees/Pk
PS95505	2 3/4"	White/Red Stripe	30
PS95529	2 3/4"	White/Stripe Mix	30
PS86509	2 3/4"	White/Black Stripe	30
PS86510	2 3/4"	White/Blue Stripe	30
PS86511	2 3/4"	Citrus Mix/Black Stripe	30
PS95506	3 1/4"	White/Blue Stripe	25
PS95530	3 1/4"	White/Stripe Mix	25
PS96009	3 1/4"	White/Red Stripe	25
PS86512	3 1/4"	White/Black Stripe	25
PS86513	3 1/4"	Citrus Mix/Black Stripe	25
PS95507	4"	White/Black Stripe	20

### 3-Tier Cleat & Tee Display

Free with purchase of 24 bags of Softspikes cleats, Champ cleats, Pride Performance Plastic Tees and/or Champ FlyTees (Mix and Match)

**PS7064CH66**



### Plain Bamboo Tees Bulk

\* Case of 10,000 Tees

Size	White	Natural
<b>2 1/8" Bulk</b>	<b>YJ023220BAM</b>	<b>YJ023226BAM</b>
<b>2 3/4" Bulk</b>	<b>YJ023235BAM</b>	<b>YJ023237BAM</b>
<b>3 1/4" Bulk</b>	<b>YJ023453BAM</b>	<b>YJ023450BAM</b>

### Plain Bamboo Tees Bagged

\* Case of 667 bags (10,000 tees)



Size	White	Natural
<b>2 1/8" Bagged</b>	<b>YJ023222BAM</b>	<b>YJ023228AM</b>
<b>2 3/4" Bagged</b>	<b>YJ023241BAM</b>	<b>YJ023243BAM</b>
<b>3 1/4" Bagged</b>	<b>YJ023423BAM</b>	<b>YJ023425BAM</b>



### Tree Saver Traditional Plastic Tees

- \* A classic profile made with recyclable ABS plastic that resists breaking, longer lasting and saves trees
- \* Stocked in white, in three height options
- \* Can be special ordered in several different colors to match style or branding
- \* Made in USA

SKU	Size	Qty
<b>PM026050</b>	<b>1 3/4" Bulk</b>	<b>5,000</b>
<b>PM026001</b>	<b>2 3/4" Bulk</b>	<b>10,000</b>
<b>PM026032</b>	<b>3 1/4" Bulk</b>	<b>5,000</b>



### Pride Performance Plastic Tee Plain

Pride Performance Tees are premium plastic tees that have special engineering and design features that provide increased stability, durability, lower friction, and better overall performance.

SKU	Size	Qty
<b>PSEPP11200</b>	<b>1 1/2" Bulk</b>	<b>5,000</b>
<b>PSEPP23400</b>	<b>2 3/4" Bulk</b>	<b>5,000</b>
<b>PSEP31400</b>	<b>3 1/4" Bulk</b>	<b>5,000</b>

### Plastic Tee Bags - Bulk

\* Recloseable bags bundles of 100

SKU	Size
<b>ULS-1292</b>	<b>3" - 4" (10-15 tees)</b>
<b>ULS-1294</b>	<b>4" - 6" (16-30 tees)</b>

\* Looking for something different? Just ask us! There are many options to choose from including other colours for the tees above to different styles like bulk FlyTees, PTS Tees, MaxxPro, stripe imprinted, and more.



### Premium Printed Wood Tees - Shank Imprint

- \* 1 and 2 colour shank printed tees are priced and sold in increments of 1,000
- \* Made and printed in North America by Pride Sports
- \* 100% Hardwood Golf Tees
- \* Best quality printing and maximum durability
- \* min 5,000 white only
- \*\* white only and natural only
- \*\*\* White only

Size	1 Colour	**2 Colour	***3 Colour
*1 5/8"	PSPP15801	N/A	N/A
2 1/8"	140194-1CS	140194-2CS	N/A
2 3/4"	140196-1CS	140196-2CS	PSPP15801
3 1/4"	140198-1CS	140198-2CS	PSPP15801

**X-BAGGING**

**Bagging Charge (per 1,000 tees)**

**Colours Available:**

- White
- Cit Green
- Red
- Dk Green
- Natural
- Cit Pink
- Black
- Cit Orange
- Dk Blue
- Yellow
- Orange

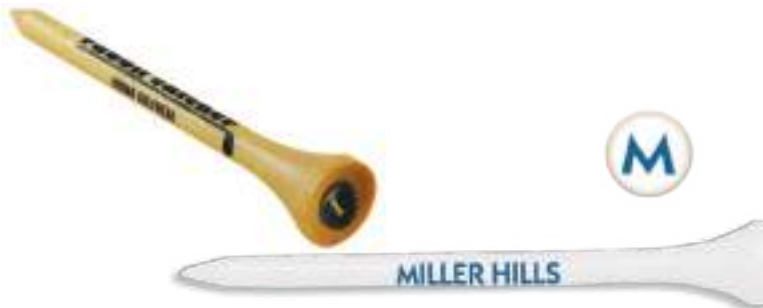

### Premium Printed Wood Tees - Cup Imprint

- \* Cup printed tees are priced at 1,000 and sold in increments of 5M
- \* Made and printed in North America by Pride Sports
- \* 100% Hardwood Golf Tees
- \* Best quality printing and maximum durability
- \* min 5,000 white and natural only

Size	*1 Colour Cup
2 1/8"	140194-1CUP
2 3/4"	140196-1CUP
3 1/4"	140198-1CUP

Size	*1 Colour Shank & 1 Colour Cup
2 1/8"	140194-1CS1CUP
2 3/4"	140196-1CS1CUP
3 1/4"	140198-1CS1CUP

Size	*2 Colour Shank & 1 Colour Cup
2 1/8"	140194-2CS1CUP
2 3/4"	140196-2CS1CUP
3 1/4"	140198-2CS1CUP

**X-BAGGING**

**Bagging Charge (per 1,000 tees)**

**Colours Available:**

- White
- Natural



**Colours Available:**

- White
- Red
- Natural
- Black
- Dk Green

### Custom Premium Wood Tees with Tins

- \* Tees sold with 1-color imprint, placed in polybag inside Tin
- \* Natural, white, red, black or dark green

Size	1 Colour 250	1 Colour 500
2 1/8"	PSPP281250	PSPP281500
2 3/4"	PSPP241250	PSPP241500
3 1/4"	PSPP341250	PSPP341500

### Combo Packs

Choices include wood or plastic tees, plastic or poker chip ball markers, and several different divot tools. Let us help tailor a pack for your budget and event size.



Bamboo Tees available upon request 2 sizes

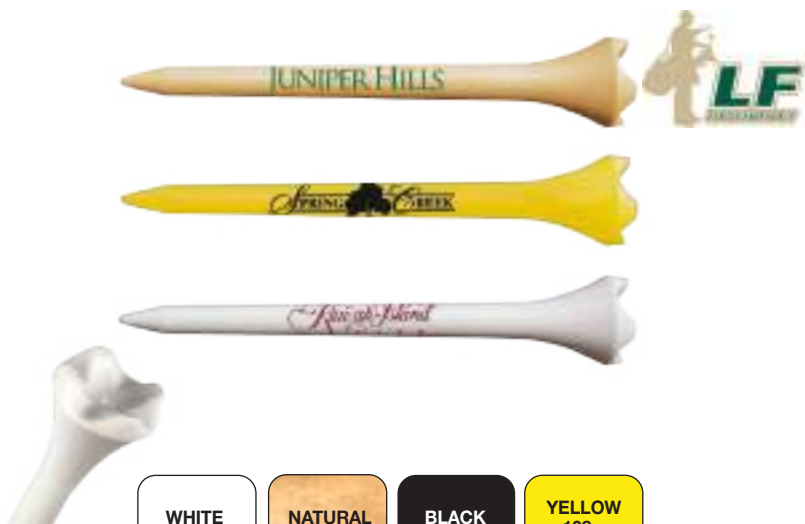

**Pride Performance**

Engineered with a four-prong cup design, for less friction between the tee and the golf ball during club impact

- \* White only min 5,000
- \*\* White and natural only
- \*\*\* White only



Size	1 Colour Shank
*2 1/2"	PSPPE11201
2 3/4"	PSPPE23401
3 1/4"	PSPPE31401

Size	**2 Colour Shank
2 3/4"	PSSPE23402
3 1/4"	PSSPE31402

Size	***3 Colour Shank
2 3/4"	PSSPE23403
3 1/4"	PSSPE31403

**X-BAGGING** Bagging Charge (per 1,000 tees)



**FLYTee**

- \* Printed tees sold in 1M increments only
- \* Prices are per 1M & before discount
- \*\* White and natural only
- \*\*\* White only



Size	1 Colour Shank
2 3/4"	PSFP23401
3 1/4"	PSFP31401

Size	**2 Colour Shank
2 3/4"	PSFP23402
3 1/4"	PSFP31402

Size	***3 Colour Shank
2 3/4"	PSFP23403
3 1/4"	PSFP31403

**X-BAGGING** Bagging Charge (per 1,000 tees)







WHITE

YELLOW  
108

CITRUS  
ORANGE  
811C2X

CITRUS  
GREEN  
802C2X

CITRUS  
PINK  
806C2X

Neon  
MIX

### MaxxPro Oversized Golf Plastic Tees

Engineered with a four-prong cup design, for less friction between the tee and the golf ball during club impact

\*\*\* White only

Size	1 Colour Shank
2 3/4"	PSMP23401
3 1/4"	PSMP31401

Size	***2 Colour Shank
2 3/4"	PSMP23402
3 1/4"	PSMP31402

**X-BAGGING** Bagging Charge (per 1,000 tees)



### Pride Classic Plastic Tee

\* Printed tees sold in 1M increments only

\* Prices are per 1M & before discount

\* White only

\*\* White only 5,000



WHITE

Size	1 Colour Shank
2 3/4"	PSPCP2340175
3 1/4"	PSPCP3140175

Size	2 Colour Shank
2 3/4"	PSPCP2340275
3 1/4"	PSPCP3140275

Size	**1 Colour Shank 1 Cup
2 1/8"	PSPSC2450175
2 3/4"	PSPSC3450175

**X-BAGGING** Bagging Charge (per 1,000 tees)

# Söffle the soft waffle

EISOP

NOT ALL WAFFLES ARE CREATED EQUAL!  
 18" x 40", Players Towel, 9.5" Cut Out  
 11 colors, 2-4 Week Turnaround  
 36 Pc Min - Mix Colors Okay Embroidery  
 Buy 72 with logo get 12 N/C  
 Landscape or Portrait



# Söffle the soft waffle

**EISOTF**

16" x 24", Carabiner Clip,  
9 colors, 2-4 Week Turnaround  
36 Pc Min - Mix Colors Okay Embroidery  
Flat Landscape  
Flat Portrait  
TriFold Portrait  
TriFold Landscape



Red/Black    Pink/Blue    Black/Dk Gray    White/White    Royal/Silver    Navy/Silver    Orange/Blue    Silver/Black    Shamrock/Black

# Söffle the soft waffle

EISOG

16" x 16", Carabiner Clip.  
9 colors, 2-4 Week Turnaround  
36 Pc Min - Mix Colors Okay Embroidery  
48 Pc Basket Available



Silver/Black



Black/Dk Gray



Shamrock Green/  
Black



White/White



Pink/Blue



Red/Black



Orange/Blue



Navy/Silver



Royal/Silver



# microfiber greens towel

Cw clip wipes®

**GOLF'S BEST SELLING MICROFIBER TOWEL!**

16" x 16", Includes carabiner clip.  
Comes in 12 colors.



## Microfiber Greens Towels

EI061831 - Pine Forest	EI061832 - Citrus Orange
EI061823 - Jet Black	EI061827 - Sterling Silver
EI061824 - Royal Blue	EI061828 - Pure White
EI061825 - Cardinal Red	EI061829 - Navy Blue
EI061826 - Shamrock Green	EI061830 - Awareness Pink
EI061833 - Desert Sand	EI061834 - Caribbean Blue
EI061822 - Starter Pack (36 towels)	

### Greens Towel Features

**Perfectly Sized** - Most golf towels are too big and bulk. At 16" x 16" Greens Towel is the "Convenient Microfiber Golf Towel".

**Cleans Fast** - Made of Super Absorbent microfiber that holds up to 7 times its weight in water and cleans faster, Greens Towel removes dirt like a magnet keeping your grooves clean to help golfers play your best. Never miss a shot because of dirty golf equipment.

**Easy-to-use** - Greens Towel comes with a convenient carabiner clip that quickly attaches to your golf bag.

# laser greens towel

Cw clip wipes®

Logo Friendly - Greens Towel looks great when customized with your logo or a tournament logo by laser etching, screen printing, or embroidery. 48 Pc Min - No Set Up, Mix Colors,



# gtcool

CLIP WIPES®

soak it · wring it · snap it

EIGTC

16" x 36", Optimum  
3 colors.

Cooling Towel.



Cardinal Red

Sterling Silver

Navy Blue



**36 Pc. Display**  
Choose your colors.  
Free bucket w/ 1st order.

# Söffle cooling

TECHNOLOGY

soak it · wring it · snap it

EISOC

16" x 36", Ultimate

Cooling Towel

6 Colors - Logo Program Dye Sublimation  
36 Pc Min - Mixed Colors Okay



Shamrock Green

Caribbean Blue

Orange Crush

Jet Black

Cardinal Red

Navy Blue



**36 Pc. Display**

Choose your colors.  
Free bucket w/ 1st order.





### Amphibian Towel

Perfect for both wet and dry playing conditions. On a Dry Day; Wet the interior to clean clubs and use the exterior cotton jacquard to dry them. On a Rainy Day; Leave the interior terry towel dry and allow the exterior cotton jacquard towel to get wet. Use the interior towel to dry club grips and wet hands! The wet exterior towel is now perfect for cleaning clubs.

- 1061811** Black
- 1061812** Blue
- 1061813** Red
- 1061814** Pink
- 1061815** Orange
- FG061816** Green

### Frogger Golf Ball Towel

Wet the inner layer of the towel to clean your ball, then dry it on the outside Carabiner clip attaches to any bag or belt Cleaner golf balls give putts more accuracy and control Fits in your pocket 4" x 4"

**FGCA6250BTCBK**



### Trunk Golf Gear Organizer

- \* Made of durable nylon
- \* Includes adjustable compartments, vented golf shoe area, and convenient handle
- \* Can be screened or embroidered with your logo!
- \* See price list for details

**1053105**

### EZ-Dri Rain Cover

- \* Easy access to all pockets on your golf bag
- \* Stays soft in cold weather
- \* Wraps easily around bag with velcro fasteners
- \* Dual zippered opening for easy access to clubs

**PROSRH017**



### Rain Tek Bag Cover

Unique high wind protection strap. Finally, a rain cover made specifically for 3-wheel cart owners. Structural Foam Hood and Full Bag Design stand out from the crowd. Convenient side and lower pocket access panels. Easy club access. Rainproof pocket for scorecard. Unique high wind protection strap.

**PROSRC001**

### Cabretta Leather Gloves

This Premium Cabretta glove offers you an advanced style and fit for pure performance. Crafted with Lycra inserts and gossets your Golf59 glove offers you a premium glove for extra comfort, fit and durability

**Men's Left Hand**

THG5902-MREG-WHT-LHS	- Small
THG5902-MREG-WHT-LHM	- Medium
THG5902-MREG-WHT-LHML	- Med-Large
THG5902-MREG-WHT-LHL	- Large
THG5902-MREG-WHT-LHXL	- X-Large

**Men's Right Hand**

THG5902-MREG-WHT-RHS
THG5902-MREG-WHT-RHM
THG5902-MREG-WHT-RHML
THG5902-MREG-WHT-RHL
THG5902-MREG-WHT-RHXL



### Synthetic/Leather Combo Gloves

The Premium Cabretta palmed synthetic glove offers you an advanced style and fit for pure performance. Crafted with lycra inserts and gossets this premium glove offers you extra comfort, fit and durability.

**Men's Left Hand**

THG5901-MREG-WHT-LHS	- Small
THG5901-MREG-WHT-LHM	- Medium
THG5901-MREG-WHT-LHML	- Med-Large
THG5901-MREG-WHT-LHL	- Large
THG5901-MREG-WHT-LHXL	- X-Large

**Men's Right Hand**

THG5901-MREG-WHT-RHS
THG5901-MREG-WHT-RHM
THG5901-MREG-WHT-RHML
THG5901-MREG-WHT-RHL
THG5901-MREG-WHT-RHXL

**Ladies Left Hand**

THG5901-LDY-WHT-LHS	- Small
THG5901-LDY-WHT-LHM	- Medium
THG5901-LDY-WHT-LHL	- Large
THG5901-LDY-WHT-LHXL	- X-Large

**Ladies Right Hand**

THG5901-LDY-WHT-RHS
THG5901-LDY-WHT-RHM
THG5901-LDY-WHT-RHL
THG5901-LDY-WHT-RHXL

### Junior Gloves

Designed specifically for growing junior golfers, this all weather glove comes in three sizes and features a stretch panel on the back

**Juniors Left Hand**

THG5901-LDY-WHT-LHS	- Small
THG5901-LDY-WHT-LHM	- Medium
THG5901-LDY-WHT-LHL	- Large

**Juniors Right Hand**

THG5903-JR-WHT-RHS
THG5903-JR-WHT-RHM
THG5903-JR-WHT-RHL





'At the heart of every great product is a great design.  
At the heart of great design is a great story...'

## LEGENDARY DESIGN | BORN IN THE HIGHLANDS

CustomX is trusted by the finest courses Worldwide to design and create memorable gifts.

Driven by the past of our sport and compelled to embrace the future, we strive to make unique products that tell your story.

Designed by our team in the UK and manufactured to exacting standards we utilise ancient and modern crafts to produce exceptional products.

When you desire original and demand the very best, choose CustomX.



### DivA Features

Push Button auto open function \* MTech fork to enable better push repairs \* 10% Lighter than previous models  
 \* 24mm removable ball marker \* Putter rest \* Aircraft grade aluminum \* Lightweight



#### DivA Aero ST

The DIVA AERO ST has changed the game in divot repair. 10% lighter than previous models. Now with all new soft touch handle. Easy to use for great repairs every time Available in Pink, Green, Blue, Red, White and Black

**TFPH00**

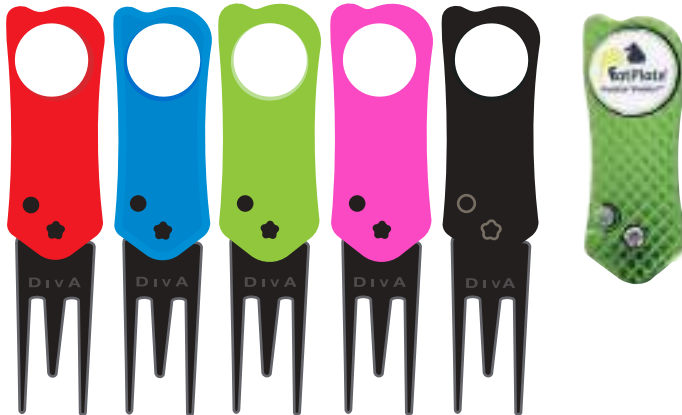

#### DivA Pro

The DIVA PRO is the logo leader for corporate and golf retail sales. Lazer lite aluminium allows for a permanent logo position on the rear of the tool and the 24mm nickel marker can be full colour branded Rear laser engrave 55mm Available in Red, Blue, Green, Pink, and Black

**TFPH00-**



#### Galaxy Custom

Take your corporate gift to the next level with the latest cool branding technique for our PRO tools. Lazer lite aluminium allows for a permanent all over logo on the front and rear of the tool. The 24mm nickel marker can be full colour branded.

**TFPHGAL**



#### Lily Pad Display

Sleek countertop display holds 36 DivA Aero ST or DivA Pro Free with 72 tools

**TFDISPLAY**



#### 24mm Resin Dome Markers

- \* Add your course or tournament logo
- \* Antique Brass, Gun Metal, Antique Silver or Bright Nickel finish
- \* Min 50

**140334-**



### Bent Tab Repair Tools

\* Pricing based on customization, minimum 1000  
 \* Set up charges apply on first order and are waived for reorders within 18 months

Engraved	
140420	- Antique Brass
140430	- Copper
140450	- Pewter

**140400** Set up charges



### Plastic Repair Tools

Repair Tool	
YJ020006	- Plain Assorted Colours
140155	- Printed Premium One Colour Imprint
140156	- Printed Premium Full Colour Digital Print

**Colours Available:**

- White
- Yellow
- Cit Green
- Red
- Orange
- Cit Pink
- Black
- Dk Green
- Cit Orange
- Dk Blue



### Pride One-Prong Divot Repair Tool - With Thumbrest

SKU	QTY
PSDRTP10001	250
	500
	1000
	2500
	5000
PSDRTP100	- Plain sold in 250's

**Colours Available:**

- White
- Black
- Dk Green
- Dk Blue



### Quik-Fix Repair Tools

• Made of anodized aluminum  
 • Priced individually, sold in bags of 25

Repair Tools	
KM020310 - Black	KM020312 - Green
KM020314 - Blue	



**Dome Logo Ball Markers**

- \* 24 mm marker with full colour resing dome logo
- \* Choose from our stock designs or add your own logo
- \* Min 50 for custom logo

**140334-**



**Printed Poker Chip Ball Markers**

- \* Double sided 4- colour process printed poker chip
- \* Free display with purchase of 500+
- \* Colour mix up to 4 colours

**141280**

**Marker**

**PSPC13150**

**150 Markers plus free display**

**PSPC13000**

**500 Markers plus free display**

**PSPC13300**

**300 Markers plus Free Wooden Display**

**Colours Available:**

- Natural    Grey    Navy    Black    Cit Green
- Red    Yellow    Lt Blue    Dk Blue    Cit Pink
- Orange    Dk Green



(Full Colour Digital Print)

**Colours Available:**

- White    Yellow    Cit Green    Dk Blue    Black
- Red    Orange    Cit Pink    Cit Orange    Dk Green

**Plastic Ball Marker**

Ball Marker	Qty
YJ021015 - Plain Quarter Size - Assorted	Boxes of 1,000
YJ021007 - Plain Dime Size - Assorted	Boxes of 1,000
PSPQ62591 - Premium Printed 1 Colour (min 1,000) Quarter Size	Sold in increments of 250
PSPQ62591-DIG - Full Colour Digital Print	Sold in increments of 250
PSPQ62592 - Premium Printed 2 colour (min 1,000) Quarter Size	Sold in increments of 250
PSPD61091 - Premium Printed 1 Colour (min 1,000) Dime Size	Sold in increments of 250



**2BM UNIQUE PUTT LINE**

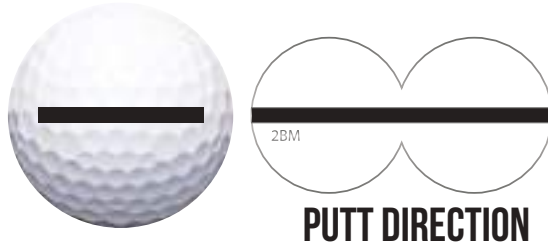

**Shot Saver**

Rules compliant 49mm  
 Easily find your line - Sink more putts - Save shots!  
 Add your logo for that truly unique gift item.  
 Buy 24 pieces and get free of charge custom logo and 24 piece counter display  
 \*Available in white, blue, red and black

<b>2BM003</b>	<b>* Blister Pack</b>
<b>2BM0001</b>	<b>* Blank Loose</b>
<b>2BM0001PREPACK</b>	<b>* 24 pc with display</b>
<b>2BM0001PREPACK-LOGO</b>	<b>* 24 pc with display - Add logo</b>



**Green Saver**

The new Green Saver tool is the perfect way to keep your Shot Saver at hand around the green. Light weight and great for repairing your pitch/divot marks.. Available in white, blue, red and black

<b>2BM016</b>
---------------



EISINGER SMITH



### Easy View Magnetic Leather Wallet

Friendly front pocket wallet with a strong magnetic money clip closure and easy access card slots. Stylish contrast stitching. Additional side pocket for business cards and receipts.

Product Size  
3" x 4" x .5"

**EISW-936**

**Black or Brown**

**EISW-936-DAK**

**Premium Leather Brown**



### Magnetic Money Clip Wallet

Sleek design, comfortable styling and contrast stitching, our top-grain leather wallet with magnetic money clip has it all. Customize with a full color dome or frost etch medallion.

Product Size  
2.675" x 3.625"

**EIMW-976**

**Black or Brown**



### Currency Organizer Wallet

Black or brown top-grain leather exterior and turned edge construction with contrasting russet nubuck interior and stylish contrast stitching. Center currency bar and plenty of pockets, both inside and out for credit and business cards, providing both easy access and security.

Product Size  
2.75" x 3.75"

**EIFW-99**

**Black or Brown**



### Dakota Credit Card Bi Fold

Top grain leather with top opening currency pocket and 7 cards slots plus ID holder. This top of the line wallet has a nylon lined interior with a rugged tone on tone exterior look that ages beautifully over the course of its life

**EICREDIT**

\* Mix and match your styles and colours to meet the min 24



EISINGER SMITH



### Two-Tone Easy-View Leather Magnetic Wallet

Friendly front pocket wallet with extra strength fold-over magnetic closure to secure currency. Easy access card slots with an additional inside pocket for business cards and receipts. Complete with contrasting top grain leather and stitching.

Product Size  
4" x 2.75" x .5"

**EITT-981**    **Black/Brown**



### Two-Tone Leather Magnetic Wallet

Sleek design with contemporary contrasting leather and stitching. Inside pocket for credit cards and secure magnetic fold-over to hold currency.

Product Size  
2.675" x 3.625" x .5"

**EITT-982**    **Black/ Brown**



### Two-Tone Leather Currency Organizer

Top grain leather wallet with center currency bar. Contrasting full interior leather and stitching with front and back pockets for credit and business cards.

Product Size  
2.75" x 3.75" x .375"

**EITT-983**    **Black/Brown**



### Two-tone Leather Money Clip

Complete with two high strength magnets to secure your currency. Contrasting leather interior and stitching

Product Size  
1.5" x 2.625" x .312"

**EITT-984**    **Black/Brown**



### Slim Wallet Bi-Fold

Black or brown top-grain leather exterior with stylish contrast stitching. Plenty of pockets, for your credit and business cards, providing both easy access and security.

**EIBI-FOLD**    **Black or Brown**

\* Mix and match your styles and colours to meet the min 24



EISINGER SMITH



### Dakota Leather Draw String Pouch

Twice dyed leather with nylon liner divided to protect jewelry and other valuables. Bucket bottom with drawstring closure

**EIDAK-503**

### Dakota Leather Travel Shave Kit

Our shave kit is ideal for the long trip or a day at the club. Keep your personal essentials organized in our moisture resistant nylon lined kit for easy care. Main zipper compartment opens wide and second side zipper compartment pocket for small accessories complete this kit.

**EIDAK-505**

### Dakota Leather Zipper Pouch

Zippered, rugged, durable top grain leather bag with non-abrasive nylon lining.

**EIDAK-507**

### Dakota Leather Modern Shave Kit

Toiletry case with medallion imprint is a great gift idea for the traveling golfer, with room for all the day to day travel essentials.

**EIDAK-502**

### Dakota Leather Golf Shoe Bag

Rugged top grain leather with easy clean nylon interior. Complete with friendly full length zipper access, and ample room for shoes and additional personal items.

**EIDAK-506**

### Dakota Leather Weekender Bag

Rugged top grain leather with easy clean nylon interior. Complete with friendly full length zipper access, and ample room for shoes and additional personal items.

**EIDAK-WEEKEND**

\* Mix and match your styles and colours to meet the min 24





EISINGER SMITH



### Mesa Leather Draw String Valuables Pouch

Contrasting top grain leather – interior divider panel and additional ring pocket to help secure and separate items. Full color medallion imprint.

Product Size  
7.25" x 7.25" x .125"

**EITT-503**



### Mesa Leather Hanging Valet

Contrasting top grain leather with moisture friendly large nylon interior for all your personal items. Convenient tuck-away hook attaches to vanity towel bar or locker hardware. Ideal for travel or play. Full color or etch imprint

Product Size  
7" x 11" x 4"

**EITT-504**



### Mesa Leather Travel Shave Kit

New to our Mesa Leather Collection, our shave kit is ideal for the long trip or a day at the club. Keep your personal essentials organized in our moisture resistant nylon lined kit for easy care. Main zipper compartment opens wide and second side zipper compartment pocket for small accessories complete this kit.

Product Size  
10" x 5" x 4.5"

**EITT-505**



### Mesa Leather Golf Shoe Bag

Contrasting top grain leather with easy clean nylon interior. Complete with friendly full length zipper access, inside zippered divider pocket and air vents. Ample room for shoes and additional personal items.

Product Size  
14.5" x 8.5" x 4"

**EITT-506**



### Mesa Leather Golf/Travel Utility Bag

Crafted in contrasting top grain leather. A functional and stylish companion to every golf bag or an overnight trip. Generously sized to organize and protect your valuables and personal accessories. Secure top zip and spring clip for bag attachment.

Product Size  
8" x 6" x 1"

**EITT-507**

\* Mix and match your styles and colours to meet the min 24



EISINGER SMITH



### Scorecard Holder

A must for the avid golfer. Sleek styling for pocket friendly access. Ample room to store previous rounds. Front medallion imprint to showcase your club or corporate full color logo art.  
6" x 4.25". Color: Black  
Product Size  
6.5" x 4.375" x .375"

**EISH-870**



### Leather Valuables Pouch w/drawstring

Supple black leather with nylon liner divided to protect jewelry and other valuables. Includes stylish contrast stitching and bucket bottom with drawstring closure. Black only  
Product Size  
6" x 7" x 2"

**EIVP-66**



### Leather Shoe Bag

Classic leather coupled with nylon interior, leather like bodypanels and sewn construction adds to this stylish design. Generously sized to fit shoes and an inside pocket for jewelry or valuables storage. Detailed with a sturdy strap handle and full-zipper closure. A full-color medallion with epoxy or satin etch imprint will highlight your logo beautifully. Black only  
Product Size  
14.5" x 8.5" x 4"

**EITL-606**



### Leather Hanging Valet Case

Popular travel and locker companion that conveniently organizes your personal accessories. Top grain leather with zipper closure. Hang-it-any where hook and easy to clean nylon lining. Black only  
Product Size  
7" x 11" x 14"

**EITL-604**



### Leather Valuables Zippered Case

Zippered, soft, yet durable top grain leather bag with non-abrasive nylon lining and separate inside pocket for currency or jewelry. Black with contrast stitching.

**EIZP-78**

\* Mix and match your styles and colours to meet the min 24



EISINGER SMITH



### Leather Trimmed Travel Shave Kit

New to our Leather & Canvas accessories, our shave kit is ideal for the long trip or a day at the club. Keep your personal essentials organized in our moisture resistant nylon lined kit for easy care. Main zipper compartment opens wide and second side zipper compartment pocket for small accessories complete this kit. Decorated with a 1" medallion.  
Product Size 10" x 5" x 4.5"

**EITF-805**

### Leather & Canvas Hanging Travel Valet

Ideal for the long trip or a day at the club. Convenient hook attaches to the vanity towel bar or locker hardware. Moisture-resistant nylon lining for easy care. Sized to keep all your personal essentials organized. Rugged leather trim and piping with sewn construction.  
Product Size 7" x 11" x 4"

**EITF-804**

### Leather Trimmed Valuables Pouch

Functional and stylish companion to every golf bag. Generously sized with sewn construction and leather trim. Friendly nylon lining with heavy-duty zipper closure. Spring clip for easy attachment and removal.  
Product Size 8" x 6" x .75"

**EITF-76**

### Leather & Canvas Valuables Drawstring Pouch

Durable, lightweight canvas exterior and leather trim with nylon interior. Divider panel and additional ring pocket to help secure and separate items. Drawstring closure.  
Product Size 6" x 7" x 2"

**EITF-64**

### Leather & Canvas Shoe Bag

Traditional styling and exceptional workmanship combine to make this shoe bag an accessory that will offer years of use and convenience. Rugged canvas with top-grain leather trim and piping and full-length zipper. Ample size for shoes and additional personal items. Easy-clean, moisture-resistant nylon interior, zippered divider pocket, air vents and sturdy leather handle all add up in making this truly unique and a favorite for the golf enthusiast.  
Product Size 14.5" x 8.5" x 4"

**EITF-806**

\* Mix and match your styles and colours to meet the min 24



EISINGER SMITH



### Two-Tone Draw String Valuables Pouch

Create a statement when choosing from any four color combinations. A secure draw string with cinch closure to protect your valuables while on the course or traveling.

Additional Information

Colors: red and black, white and black, green and black, blue and black.

Product Size 4" x 7"

EIVC-63



### Top Zip Valuables Utility Bag

Our colorful zippered valuable pouches will keep your essentials safe when not in play. Our pouches are lined with a non-abrasive felt and sewn in contrast stitch for a great look. Four colors to choose from with the highlight being your custom one inch medallion

Product Size 8" x 6" x .875"

EIVC-73



### Two-Tone Shoe Bag

Our colorful zippered valuable pouches will keep your essentials safe when not in play. Our pouches are lined with a non-abrasive felt and sewn in contrast stitch for a great look. Four colors to choose from with the highlight being your custom one inch medallion

EITV-83

## How to order from the Eisinger Smith Collection

All products come with your course or event logo

Minimum order per logo is 24 pieces.

### Top Selling Tip – Choose an assortment! This leads to higher sales and allows potential corporate and tournament customers see several options.

You can choose any variety of items from the Eisinger Smith line to make up your order of 24 or more pieces.

Order ship direct from supplier, and lead times are 2-3 weeks from approval and deposit.

Frosted Etch

Make your logo stand out with the multi-dimensional look to enhance the fine details in your logo. Frosted etch is known for its durability. The etching combines the artistry of chemical engraving to create an extraordinary ball marker that is unmatched!

Color Doming

Is a four-color process with unlimited colors to enrich the details in your logo. It's finished with an epoxy dome to preserve the colors and add a finish that will last for years to come.



### ORCA Drinkware Features

- \* 18/8 Stainless Steel, Double Walled, Vacuum Sealed Body
- \* Holds ice for up to 24 hours
- \* Keeps beverages warm for up to 6 hours
- \* Screw On Whale Tail Flip Top Lids (Chasertini presses on)
- \* Laser Etched Drinkware
- \* Minimum ORCA Drinkware order is 6 pieces.
- Drinkware cases must contain the same product type, style, color and design.
- Drinkware must ship in full case multiples of 6 (no split or partial cases).



16oz Chaser



22oz Hydra



12oz Vino



12oz Tini



12oz Barrel

### Chaser

- Industry-leading cold and heat retention
  - Top rack dishwasher safe
  - Tough powder coast finish with no-sweat body
  - Premium stainless steel, with double-walled vacuum seal
  - BPA-free whale tail flip lid
- Pearl, Black, Navy, and Hammered White (in 16oz only)

<b>ODCH16</b>	Chaser 16 oz
<b>ODCH22</b>	Chaser 22 oz
<b>ODCH17</b>	Chaser 27 oz

### Hydra 22oz

- Industry-leading cold and heat retention
- Screw-top, easy-flow sport lid with ORCA whale tail handle
- Top rack dishwasher safe
- Tough powder-coat finish with no-sweat body
- Seamless inner wall with no welds to rust or contaminate your favorite beverage
- Premium stainless steel, with double-walled vacuum seal
- \* Pearl, Black, and Navy

<b>PSH22</b>
--------------

### ORCA Barware Features

- Industry-leading cold and heat retention
- Top rack dishwasher safe
- Premium stainless steel, with double-walled vacuum seal
- Tini has a BPA-free whale tail flip lid
- Barrel, Vino and 16oz Chaser have a BPA-free, screw-on, spill proof whale tail flip lid
- Tough powder coat finish\* with no-sweat body
- \* Dark Oak barrel has a printed finish and is not powder coated.

### Vino

<b>PSVIN12</b>	Pearl & Dusty Rose
----------------	--------------------

### Tini

<b>PSTINI</b>	Pearl & Seafoam
---------------	-----------------

### Barrel 12oz

<b>PSBAR12</b>	Wood Grain and Black
----------------	----------------------



### PGA Merchandise Bags

- \* 15" x 20"
- \* Bundle of 250
- \* Reusable merchandise bags

**PGABAG**    **PGA**



### Custom Merchandise Bags

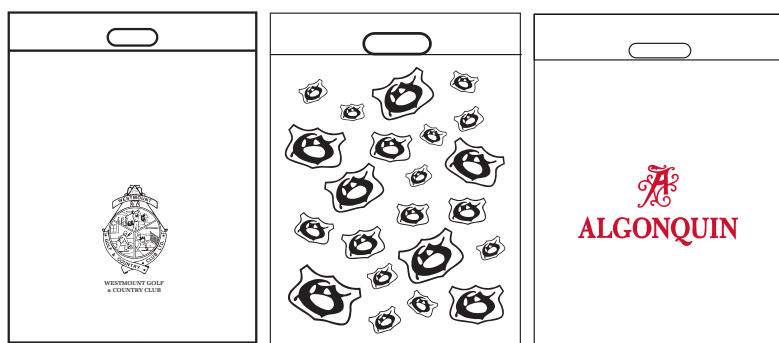

- \* Custom Merchandise Bags are available to order all season!
- \* Thicker material meets all new provincial REUSABLE bag policies
- \* Smaller runs of 5000 bags now an option!
- \* Sold in multiples of 100 (minimum of 5,000)
- \* w15" x h20" + 3" fold white 2.5 mil

**MP070308**    **Custom**

**MP070340**    **Set Up**



### SunTek Windcheater Umbrella



- \* 68" Double canopy construction with venting system
- \* Silver coating protects from harmful UV rays!
- \* Add your logo to any umbrella!

**PROUWCUV-BLK**    **Silver/Black**

**PROUWCUV-BLU**    **Silver/Blue**

**PROUWCUV-GRN**    **Silver/Green**

**PROUWCUV-YEL**    **Silver/Yellow**

**PRUMB**    **Screening**

\* Selection of umbrellas will vary please contact sales rep for stock availability



### Ultra-Lite Umbrella

- \* 62" All fiberglass construction makes for a strong and lightweight umbrella
- \* Logo friendly, screening run charges and set ups extra

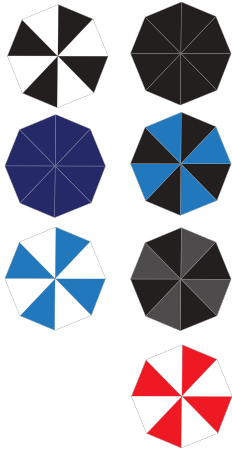

<b>PROUMBBB</b>	Black
<b>PROUMBBBL</b>	Black/Blue
<b>PROUMBBG</b>	Black/Grey
<b>PROUMBBW</b>	Black/White
<b>PROUMBNN</b>	Navy
<b>PROUMBNNW</b>	Navy/White
<b>PROUMBRW</b>	Red/White
<b>PRUMB</b>	Screening

### Windcheater Umbrella

- \* 62" Double-canopy design vents wind to help prevent the umbrella from inverting
- \* Add your corporate or sponsor logo

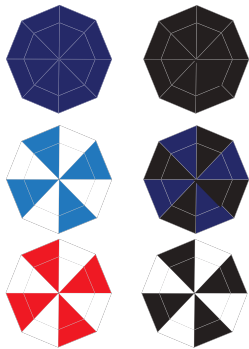

<b>PROUWCBB</b>	Black
<b>PROUWCBBL</b>	Black/Blue
<b>PROUWCBW</b>	Black/White
<b>PROUWCNN</b>	Navy
<b>PROUWCNW</b>	Navy/White
<b>PROUWCRW</b>	Red/White
<b>PRUMB</b>	Screening

### Ultimate Umbrella

- \* 52" -Fiberglass shaft with EVA handle, windproof with manual open, two colour combo
- \* Add your logo to any umbrella, minimum 35 pcs



<b>SRU782BK</b>	Black
<b>SRU787BL</b>	Blue
<b>SRU787LG</b>	Lime Green
<b>SRU782OR</b>	Orange
<b>SRU782RD</b>	Red
<b>SRSETUP</b>	Screening

- \* Selection of umbrellas will vary please contact sales rep for stock availability

## Tournament Packages (36 Players)

Packages can be customized for any tournament size!  
Buy a package and save 10%!

### Night Golf Package With Glow Ball

**NF010990Glow**

- 54 Glow balls with green stick
- 18 Colour Morphing Tee Markers
- 1 6" green sticks 25pk
- 1 6" red sticks 25pk
- 2 6" sticks 25pk assorted
- 1 22" glow necklace 50pk
- 1 Cup rings 9pk LED
- 1 10" Glow markers (25pk asst)
- 9 Flag markers x 9
- 1 Bracelets - 50 x assorted

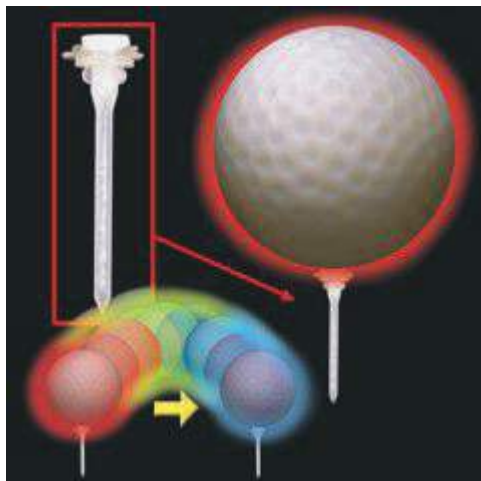

### Night Golf Package With Led Ball

**NF010990LED**

- 54 Night Flyer CL LED Balls - Assorted colours
- 18 Colour Morphing Tee Markers
- 1 6" green sticks 25pk
- 1 6" red sticks 25pk
- 1 Tube of 22" Necklaces
- 54 Assorted reusable LED markers
- 9 LED Flag Markers
- 1 Tube of Cup Rings
- 1 Bracelets - 50 x assorted

### Night Flyer Cl Pro Led Ball

- \* Official size and weight
- \* Lights up on impact
- \* Stays lit for 8-10 minutes
- \* Timer restarts with each impact

<b>NF010979</b>	<b>White</b>
<b>NF010980</b>	<b>Yellow</b>
<b>NF010981</b>	<b>Red</b>
<b>NF010982</b>	<b>Blue</b>
<b>NF010983</b>	<b>Green</b>
<b>NF010984</b>	<b>Pink</b>

### Glow Flyer Ball With Stick Bulk

- \* Glow Balls come with one glow stick
- \* Glow balls and refill sticks are available in blue, green, orange, pink, and red

<b>NF010946</b>	<b>Glow Flyer Ball W/Stick - Bulk</b>
<b>NF010952</b>	<b>Jumbo Refills</b>

### Led Tee Box Marker

- \* 2.5" Colour Morphing Dimpled Tee Markers
- \* Color can be left solid red, blue or green or morph from one to the next
- \* Used as tee markers or to mark walkways or as table decorations,
- \* Please order in increments of 1

**NFLIT398EA**



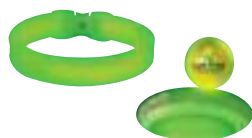
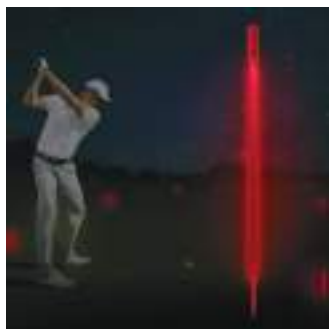

### Reusable LED Marker with Spike

We are proud to premier our exciting and super bright RE-USEABLE new extra long 14 1/2" LED Yardage Marker. These bright Golf Yardage Markers are super bright and are sure to illuminate your night golf course. Our LED Hazard Markers are perfect for lighting up Night Golf Fairways. Use them to outline greens and to illuminate tee boxes!

<b>NFLIT380</b>	<b>14.5" Green</b>
<b>NFLIT381</b>	<b>14.5" Blue</b>
<b>NFLIT382</b>	<b>14.5" Red</b>
<b>NFLIT384</b>	<b>14.5" White</b>

### 14" LED Flag Markers

Our 14" LED Golf Flag Marker utilizes (3) high-powered LEDs built into a soft foam baton that creates a 7-color morphing light show. This item has a slit down one side designed to attach slip over a flag pole. Priced and packed by the single piece, please order in increments of one marker. (3) AG-13 batteries are included, installed, and replaceable.

<b>NF010961</b>
-----------------

### LED Cup Rings

Our 9-pack of LED Green Golf Cup Rings are an alternative to the traditional glow in the dark cup rings and an easy way to quickly identify the cup. Each LED cup ring has 3 modes of operation: steady, fast/slow flash. They are battery-operated and will have approximately 9 hours of usage time. Just insert into cup either as a "bracelet" or use in "open" position and start the flash. Batteries included and installed. LED Green Cup Light Rings ( 9 per pack)

<b>NFLIT899UN</b>
-------------------

### Tee Box /Hazard /Yardage /Path Markers

Our 10" glow sticks with included plastic ground spikes come in bags of 25.

Use different colours to indicate tee-boxes, hazards, yardages, paths, or obstructions.

<b>NF010957WHT</b>	<b>10" Glow White</b>
<b>NF010957BLU</b>	<b>10" Glow Blue</b>
<b>NF010957GRN</b>	<b>10" Glow Green</b>
<b>NF010957RED</b>	<b>10" Glow Red</b>
<b>NF010957ASST</b>	<b>10" Glow Assorted</b>

### Night Golf Accessories

\* 6" Glow sticks now available in blue, green, orange, pink, red, white, and assorted

<b>NF010944</b>	<b>6" Glow Stick (25 pieces per pack)</b>
<b>NF010947ASST</b>	<b>22" Necklace Bulk (50 pieces per pack)</b>
<b>NF010953ASST</b>	<b>9" Glow Bracelets (50 pack assorted)</b>



### Golf Pencils Plain - Wood

Sold in boxes of 100

**YJ020598 - GRN** Green with Eraser

**YJ020590 - GRN** Green without Eraser

Save 10% when you buy a Case of 5000!



### Golf Pencils Plain - Plastic

Sold in boxes of 1M

**YJ020654** Black with Eraser

**YJ020645** Black without Eraser

Save 10% when you buy a Case of 5M!

### Scorecards



**Bristol:** Heavier card stock perfect with a high-gloss UV coating. Add UV to the outside with an uncoated inside (scoring grid side). Excellent for cards with photos on the cover. 12 pt 100 lbs cover

**Matte:** Has a light satin sheen coating on both sides. has a good "grab" of pencil lead when scoring. Majority of scorecards printed use this stock. 9-9.5 pt 80 lbs cover

**Opaque:** uncoated both sides, superior quality that boasts a traditional scorecard appearance and feel. 11pt 90 lbs cover



Custom  
Call for quote

Matte			Bristol	
<b>147608</b>		<b>6" x 8"</b>	<b>147608B</b>	
Qty of Cards			Qty of Cards	
5,000			5,000	
10,000			10,000	
20,000			20,000	
30,000			30,000	
40,000			40,000	
<b>147512</b>		<b>5" x 12"</b>	<b>147512B</b>	
Qty of Cards			Qty of Cards	
5,000			5,000	
10,000			10,000	
20,000			20,000	
30,000			30,000	
40,000			40,000	
<b>147412</b>		<b>4" x 12"</b>	<b>147412B</b>	
Qty of Cards			Qty of Cards	
5,000			5,000	
10,000			10,000	
20,000			20,000	
30,000			30,000	
40,000			40,000	
<b>147107</b>		<b>UV Coating</b>		



### Proximity Markers Single with Cards

Sturdy nickel plated metal frame complete with 25 cards (double sided). Refill cards are available in pack of 25.

**BY517**



### Proximity Markers Set of 4

Pack of four Proximity Markers, each complete with its own pack of 25 cards.

**BY517-4**

**Marker Set**



### Proximity Replacement Cards

Double sided, thick cardboard Proximity/Long Drive cards. Pack of 25. Size 5" X 8"

**BY517-2**



**BY180**

**BY180PRO**

### Eco-Blast Air Horn

The refill valve of the Eco Blast air horn lets you recharge using the included air pump or any bicycle pump, service station air pump or air compressor. In seconds, Eco Blast is ready to emit a powerful 120 db signal that meets all USCG. requirements. Eco Blast beats out chemical horns, too, because it operates in all weather and temperature extremes. Plus, with Eco Blast there's no worry about a potentially harmful chemical escaping into the environment.

**BY180**

**Comes with pump**

**BY180PRO**

**Can be recharged w/most pumps**



### Cart Identification Flags

\* Our Universal Flag Holder allows you to attach a flag to virtually any cart. It features a 2' white pole and either a 6x8" (DS) or 14x20" (SS) handicap flag.

<b>BY346HDCP-1</b>	<b>Disabled Symbol (Blue/White) 6 x 8</b>
<b>BY346MAR-1</b>	<b>Marshal Symbol (Blue/White)</b>
<b>BY346HDCP-2</b>	<b>Disabled Symbol (Blue/White) 14 x 20</b>
<b>BY346ROD</b>	<b>Rod Only</b>
<b>BY346</b>	<b>Universal Holder Only</b>



### Cart Key Tag

- \* Large, easily visible plastic tag
- \* Features cart etiquette on one side
- \* Includes key ring

**108287**



### Golf Cart Windshield

- \* Stores in a golf bag and installs in seconds to provide a shield against wind and rain
- \* Fits most popular golf cars
- \* Attaches with three elastic cords
- \* Super-clear material rolls up for easy storage in a golf bag
- \* Includes storage bag
- \* Fits most golf cars with roofs 47"l 36"h

**PROWS000**



### Golf Cart Storage Cover

- \* Weather Protected™ fabric won't shrink or stretch
- \* Elastic cord in bottom hem for a custom-like fit
- \* Protects golf cars from sun, weather damage and dirt
- \* Rear zipper for easy entry and installation
- \* Rear air vents reduce wind lofting and inside moisture
- \* Water-repellent fabric
- \* Reflective piping
- \* Tie-down straps to prevent blow off

**CA056192** 2 person cart cover

**Size Chart (age sizes approximate)**

29" - Junior (ages 7-12)

27" - Junior (ages 5-7)

24" - Toddler (ages 2-4)

37" & 40" - Tall/X-Tall (people 6' or taller)

35" - Men's

32" - Women's



**Mini Putter - Rubber Head**

- \* Two-way putters come in various lengths with a rubber head, steel shaft and matching rubber grips
- \* Stocked in sizes and colours in chart
- \* Any other colour/size available by Special Order at no additional cost other than shipping

1032124	24" Orange
1032127	27" Yellow
1032129	29" Red
1032132	32" Pink
1032132	32" Blue
1032135	35" Black
1032137	37" Green

**Mini Golf Balls**

- \* One piece (color completely through the ball), made of durable cut-proof material for long life.
- \* No chipping or peeling that comes from painted balls.
- \* Easy to wash and keep new looking! Sold by the dozen.

122010	Orange
122020	Green
122030	Yellow
122040	Red
122050	Blue
122060	Purple
122070	Pink
122080	Black

**Mini Golf Putter Grips**

- \* made of durable Krayton to outlast rubber grips and have molded-in washers to prevent the shaft from cutting through the cap for safety.
- \* Replacement grips are easy to install and clean up easy with soapy water making them last even longer.

TM001101	Black
TM001103	Blue
TM001107	Green
TM001108	Red
TM001110	Yellow
TM0011958011	Pink
TM001195814	Purple
TM001195815	Orange



### Grip Vise - Mitchell Pro Tour

- \* Heavy-Duty Grip Vise
- \* Quick Lever Action Clamp
- \* Easy Shaft Size Adjustment
- \* Extruded Rubber Jaws
- \* Secure Clamping

**1087128** Bench Mount

**1087140** Vise Mount

### Rubber Shaft Clamp

**BT086110**

### Utility Knife Hook Blades

**1087156** 5 Pack

### Brampton HF100 Grip Solvent

- \* Non-flammable, odourless, reusable, easy clean-up, effective with all standard grip types

**BT087043** 1 Quart (32 oz) Bottles w/ Sprayer

**BT087044** 1 Gallon Bottle

**BT087046** 5 Gallon Pail

**MGGG-DPA** Grip Solvent Catch Tray

### Grip Remover Uneekscraper

**BT087050**

### Grip Remover Needles

**1081439** Regular (5pk)

### Complete Grip Kit

**BT087040**

### Grip Tape

- \* Easy-Off release liner, excellent adhesion, quick set-up, easy clean up
- \* 24 per case

**1087004** Double Sided 2" Grip Tape 36 Yds

**1087009** 2" Grip Build-Up Tape 60 Yds

**1087019** Grip Tape - 2" X 9" Strips with Poly & Instructions  
\* (15/pk)

### Grip Tape Dispenser

**ULH-837**



BT089303



BT089350



BT089345



BT089342



BT089304



BT089359



089368



089362



BT089372



BT089370



086754

### Pro-Fix 5/10 Rapid Cure

Work-Life: 5 minutes

Ball Hitting: 10-20 minutes

**BT089303** 1.5 oz Cartridge

**BT089350** 0.85 oz Self Dispensing Syringe

### Pro-Fix 5/15 Quick Cure

Work-Life: 5-8 minutes

Ball Hitting: 20-30 minutes

**BT089345** 16 oz Kit (2 x 8 oz Bottles)

### Pro-Fix 20/20 Long Cure

Work-Life: 40 minutes

Handling: 12 hours

Ball Hitting: 20 Hours

**BT089342** 32 oz Kit (2 x 16 oz Bottles)

**BT089304** 1.5 oz Cartridge

### Dispensing Gun

**BT089359** 1.7 oz cartridges

### Epoxy Wipes

**1089368** Box of 280

### Epoxy Mixing

**1089362** Applicator Sticks (100 pk)

### Pro-Fix Rattlestop

**BT089372** 4 oz Bottle

### Pro-Fix Glass Beads (Shaft Centering)

**BT089370** 4 oz Bottle

### Metal Wood Hosel Plugs

Prevent rattles by plugging in hosel

**1086754** 20 pk



### Non-Collared Ferrules

#### Iron

1086544	.370"-.545 1/2" Sold by the Dozen
1086524	.355" Taper 3/4" Sold by the Dozen
1086540	.370"-.545 3/4" Sold by the Dozen
1086540-C	.370"-.545 3/4" Sold by 100 pack
1086544-C	.370"-.545 3/4" Sold by 100 pack
1086542	.370"-.545 1" Sold by the Dozen

#### Wood

1086526	.335" - .485 1/4" Sold by the Dozen
1086534	.335" - .545 1/2" Sold by the Dozen
1086534-C	.335" - .545 1/2" Sold by 100 pack
1086537	.350" - .545 1/2" Sold by the Dozen

\* please see sales rep for other sizes available

### Collared Ferrules

#### Iron

1086518	.370" - .545 1/2" Sold by the Dozen
1086500	.355" - .545 3/4" Taper Iron Sold by the Dozen
1086520	.370" - .545 3/4" Sold by the Dozen
1086520-C	.370" - .545 3/4" Sold by 100 pack

#### Wood

1086503	.335" - .545 1/2" Sold by the Dozen
1086509	.350" - .545 1/2" Sold by the Dozen

\* please see sales rep for other sizes available



### Shaft Extensions Graphite

1086469	Regular
1086470	Oversize (For Ultralight Shafts)

### Shaft Extensions Steel

1086456	.560"
1086458	.580"
1086460	.600"
1086462	.620"

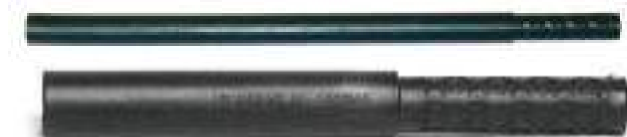

### Brass Adaptor Shims

#### Jar of 5

1086635	.335" Shaft, .350" Hosel
1086638	.355" Taper Iron Shaft, .370" Hosel







### Brass Weight Kit

**1086450** Brass Weight Kit 144 pcs



### Brass Weight Tip Weights

For steel shafts  
Wood and iron steel shafts with the tip diameters of .335 to .370

<b>1086441-1</b>	<b>1 gr.</b>
<b>1086441-2</b>	<b>2 gr.</b>
<b>1086441-3</b>	<b>3 gr.</b>
<b>1086441-4</b>	<b>4 gr.</b>
<b>1086441-5</b>	<b>5 gr.</b>
<b>1086441-6</b>	<b>6 gr.</b>
<b>1086441-7</b>	<b>7 gr.</b>
<b>1086441-8</b>	<b>8 gr.</b>



### Corks

100 pack

<b>1086750</b>	<b>Woods</b>
<b>1086751</b>	<b>Irons</b>



### Electric Heat Gun

**1086730**



### Drill Bits

<b>1086720</b>	<b>8.6mm for .335" diameter</b>
<b>1086721</b>	<b>8.9mm for .350" diameter</b>
<b>1086722</b>	<b>9.4mm for .370" diameter</b>



### Hosel Brush Drill Bit

**1086711**



### Simichrome Polish

Removes tarnish, dirt and oils, and generally renews polished metal surfaces. It leaves a protective film which retards oxidation.

**GWSIMI** 50 grams



### Lead Tape

**1081434** ½" x 36 yd Roll - 5 mil

**BT081435** ½" x 100" Roll - 5 mil



### Sanding Belts

1" x 42" 80 Grit

**1087320**



### Sanding Belt

1" x 42" Cloth Ferrule Turning

**1087325**



**Resin Core**

Resin Core is a multi-layer polymer sign available in 5 different colors. When the sheet is engraved, the interior color shows through for a high-contrast textured sign. The polymer used in Resin Core is high-impact-resistant and able to withstand the physical rigors of public space and external environments better than conventional signs. Resin Core signs won't rot, de-laminate or warp making them ideal for a variety of indoor and outdoor applications

Impact Resistant Polymer. Available in 6 different colours.

Routed Logo



Colour Fill Logo -Single Colour



Colour Fill Logo - Multi-Colour



Colour Fill Entire Sign





Size Shapes:

Arc	Rectangle	Crown
Arc with cut out corners	Rectangle with cut out corners	Crown with cut out corners

Size

3DTS12X18	12 X 18"
3DTS14X20	14 X 20"
3DTS18X24	18 X 24"

Add On Options:

3DCF	Colour Fill
3DDOME4SS	Domed Acrylic Logo
3DDAHL	Domed Acrylic Hole Layouts



Green/White/Green

White/Green/White

Blue/White/Blue

Black/White/Black



Red/White/Red



Black/Yellow/Black

Mounting Options:

Face Mount
Side Mount
Yard Arm Mount





Small Cart / Directional Signs

Available in single and double sided  
 \* Comes with 2 stainless steel spikes.

White/Green, Green/White, Blue/White, Red/White, Black/Yellow and Black/White

<b>3DF400</b>	<b>12" x 6"</b>
<b>3DF500</b>	<b>16" x 9"</b>

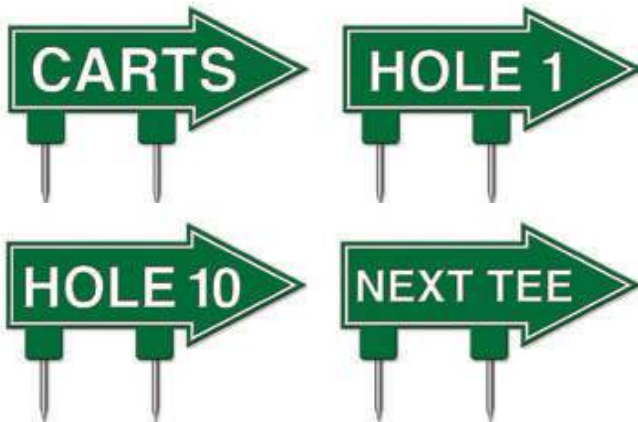

Directional Signs Double Sided (Arrow Shape) 12" x 6"

\* Comes with 2 stainless steel spikes.  
 \* Stock colour: Green/White/Green  
 \* Available in other colours for special order

<b>3DFC200</b>
----------------



All tokens priced individually and sold in 100's.

### Ball-O-Matic Tokens

1	107760	.900 Brass
2	107761	1.00 Brass
3	107762	1.125 Brass
4	107763	.800" Brass
	107765	1.125 Nickel/Silver (not shown)



### eRange Keys

Store customer's account balance. Fits easily on a key ring

105121-B	Blue
105121-G	Green
105121-Y	Yellow
105121-BLK	Black



### Wittek Plastic Replacement Picker Basket

CJ-0001
---------

### Quick Pick Molded Basket

ZHR-QPBASM	* Not shown
------------	-------------



WK71920

### Wittek 3' Drum Section

WK71920	With 2 end tires for SL90, Ball Hawk and Range Rover
---------	--

### Wittek 3' Drum Section

WK71922	For Eagle Lite
---------	----------------

### Hollrock 3' Drum Section

ZHR-QP05L	For Quick Pick
-----------	----------------

## Netting, Turf and Simulators

Not sure what turf or netting option is right for your facility? Call today and ask to speak with our specialist. With our wide range of options, whether your job is large or small, we can help ensure a quality installation on time and on budget.

Think Golf Supply House for sales, installation, and repairs of:

- Driving range and course barrier netting
- Custom hitting cages
- Tee line
- Custom putting and chipping greens for indoor or outdoor use
- Mini putt turf and accessory installations

\* Complete turnkey installations also available anywhere in Canada.

### Practice Range:

Full-scale range products complete with netting, poles and hardware.



### Indoor Academy:

We can transform any space into a permanent or removable indoor facility.

See pages 18 - 20 for more information



### Custom Residential:

Can be made available to all of your members. We will sell through you (club) or work directly with them, whichever you prefer.





### Tee Line Turf 5'x5' Hitting Mat

- \* This mat holds a real tee and allows players to hit all clubs from wedge to driver
- \* High grade polypropylene yarn designed for heavy traffic  
In use at many of the top facilities in Canada and the USA
- \* Suitable for outdoor or indoor use
- \* 1 1/4" thick

**GTMTEE5X5**



### Regular Hitting Mats

- \* The hitting surface is a dense 1/2" pile nylon top.
- \* Tee holes are cut in each side and they come with one rubber tee.

**GTMSTD5X5**

**1/2" nylon hitting surface, and  
3/8" high density foam**



**GTMPREM5X5**

**5/8" foam back for added  
cushioning**



### Indoor Outdoor 3'X5' Hitting Mat with Tee

- \* Our consumer grade hitting mat is perfect to resell for home use
- \* Poly sponge backing provides excellent shock absorption
- \* Weather resistant construction
- \* Includes one rubber tee

**CG3X5MAT**





### GSH/NAGIC Full Mat Systems

Full mat system includes - base, stance mat and two hitting strips outside dimensions 50" x 74.25" x 1 1/8" depth

**1090751** Double Sided Mat System



### GSH/NAGIC Center Strike Mat System

Center strike system includes - base, stance mats and Center Strike Mat outside dimensions 50" x 115.25"

**1090753** Center Strike Mat System



### Stance Mat

Features 100% nylon fiber on a shock resistant foam base

**1090801** Tartan Systems 45.75" square, backed with 1/2" thick foam

**1090805** Fiberbuilt Systems 46.5" square, backed with 1/2" thick foam

**1090782** GSH/Nagic Systems 47.25" square, backed with 1" thick foam



### Hitting Strips

Features our popular tee line turf backed by a heavy rubber base for stability.

Tee line turf is easy on player's joints and provides the most realistic hitting experience

**1090792** Tee Line 12" x 47" Fits GSH Original Nagic System

**1090795** Fits GSH Ver 1 Center Strike Systems 24" x 47"

**1090796** Tee Line 17.5" x 47" Fits GSH Center Strike System

**1090797** Tee Line 12" x 46" Fits Tartan & FiberBuilt System

\* Custom hitting systems available

**Barrier Net**



### Barrier Netting

Stock and custom barrier netting available  
All your supplies and installation needs!

**Impact Net**



**Archery Impact Net**



### Custom Golf Cages

Stock and custom cage netting available, We can customize whatever size cage you require. Prices vary with specifications so please call for quote

### Professional Hitting Cages

#### Professional Hitting Cage Kit

Our Professional Hitting Cage kit is ideal for high traffic warm up or practice areas. It is in use by indoor academies and retailers and outside at golf courses, resorts, and back yards all over Canada. The finished cage measures 10' x 10' x 10'.

Included in the kit are 6 x corner and 2 elbow fittings for the structure plus the full cage enclosure and a replaceable impact/baffle panel.

To keep shipping costs reasonable, you will need to provide the 10' long galvanized #6 gauge (schedule 40) steel poles which can be obtained at most local hardware, plumbing, or fencing stores.

**RDN3239**

#### Replacement 10' x 10' Bottom Weighted Hitting Panel

This 80 gauge heavy duty impact net with weighted bottom is the replacement hitting panel in our Professional Cage, and can be used in any other 10x10 cage or on its own.

**RDN3241**

HD Impact / Baffle Netting only, comes with rope border  
- 80 Gauge - 10'h x 10.25'w

**RDN3240**



### Custom Hitting Panels

We can customize whatever size panel you require. Prices vary with specifications so please call for quote

Whether you want us to design and install, or just need a reliable supply of synthetic turf and installation supplies, Golf Supply House offers a large variety of products to choose from. We work with the top Turf mills in North America to bring you durable, top quality and high performing synthetic turf. Here are four of our most popular choices.



### Tee Line Turf

1 3/8" thick polypropylene yarn.  
 Dense and durable at 152 oz per sq yd.  
 Designed for heavy traffic tee lines  
 In use at many of the top clubs in North America

**1090900**



### Fringe & Landscape Turf

1 3/4" polypropylene pile height  
 Excellent landscape product that offers thatch,  
 reducing the amount of infill needed  
 Four colour blend provides a truly authentic look

**GTMPL921**



### Premium Indoor/Outdoor Putting Turf

3/8" Pile height with a 48 oz density  
 Your premium putting turf of choice  
 Smoother ball roll and better control

**GTMPL936**



### Indoor/Outdoor Nylon Putting Turf

9/16" pile height on 5mm foam back  
 Popular for multi use install over concrete

**GTM705**





### Ultra Baskets

- \* Range baskets made of a super tough nylon/plastic material
- \* Available in green, yellow or black

Capacity	Green	Yellow	Black
<b>Warm Up (20 - 25 Balls)</b>	<b>101549</b>	<b>101550</b>	<b>101548</b>
<b>Small (40 - 50 Balls)</b>	<b>101551</b>	<b>101552</b>	<b>101553</b>
<b>Medium (70 - 75 Balls)</b>	<b>101554</b>	<b>101555</b>	<b>101556</b>
<b>Large (100 - 110 Balls)</b>	<b>101557</b>	<b>101558</b>	<b>101559</b>
<b>X-Large (150 - 175 Balls)</b>	<b>101570</b>	<b>101572</b>	<b>101571</b>
<b>Utility (350 - 400 Balls)</b>	<b>101563</b>	<b>101565</b>	<b>101564</b>



### New Stock Program Mesh Range Bags

Made of strong mesh, these range bags are economical and lightweight. Includes draw string with cord lock.

Stock Program as shown in chart below

Mesh bags are available in 4 sizes and 4 colours: yellow, green, blue, and black. For special order, longer lead times and/or higher shipping costs may apply.

<b>101031</b>	<b>Warm Up (15-20 Balls) - Green</b>
<b>101033</b>	<b>Small (35 - 40 Balls) - Black</b>
<b>101035</b>	<b>Medium (50 - 55 Balls) - Blue</b>
<b>101037</b>	<b>Large (95 - 100 Balls) - Special Order Only</b>

\* All other sizes available in yellow, green, blue, and black

### Bag Shag Ranger

100 ball capacity, No zipper to rip out. Empties easily through open top.

Designed for commercial use

<b>102311</b>
---------------

### Bag Shag

75 ball capacity, Highly polished cast spun aluminum

No warranty for commercial use

<b>102301</b>	<b>Red</b>
<b>102304</b>	<b>Black</b>

### Ballshag™

Designed to pick up 23 balls, this tool is ideal for those hard to get places where machines can't. Made from durable aluminum it is perfect for along fences or tall grass etc. The BalShag Tube now has a removable cap for storage.

<b>P183</b>	
<b>102322</b>	<b>Replacement Clips (Set of 4) for Bag Shag and Ballshag Tube</b>





### Rubber Tees

<b>RT112</b>	<b>- 1½"</b>
<b>RT134</b>	<b>- 1¾"</b>
<b>RT200</b>	<b>- 2"</b>
<b>RT214</b>	<b>- 2¼"</b>
<b>RT212</b>	<b>- 2½"</b>

<b>RT234</b>	<b>- 2¾"</b>
<b>RT300</b>	<b>- 3"</b>
<b>RT314</b>	<b>- 3¼"</b>
<b>RT312</b>	<b>- 3½"</b>



### Wood Tee Holders

Wood Tee Holders allow a regular or plastic tee to sit down in it and adjust tee height.

<b>WTH125</b>	<b>- 1¼"</b>
<b>WTH200</b>	<b>- 2"</b>

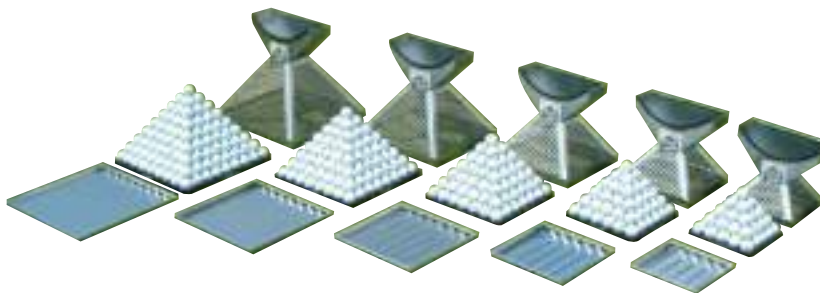

### The Original Pyramid Builder

- \* Improves the look of the tee line
- \* Easy to fill, just pour in balls, no need to turn over unit
- \* American manufactured
- \* Extremely durable
- \* Made with Stainless and Galvanized steel



Capacity	Stackers	Metal Trays	Plastic Trays
55 Balls	<b>108363</b>	<b>108366</b>	<b>108365</b>
91 Balls	<b>108356</b>	<b>108359</b>	<b>108358</b>
140 Balls	<b>108350</b>	<b>108353</b>	<b>108352</b>
204 Balls	<b>108341</b>	<b>108344</b>	<b>108343</b>
285 Balls	<b>108330</b>	<b>108332</b>	<b>NA</b>



### Rubber Ball Tray

- \* 100% rubber base is flexible and very durable
- \* Almost silent when balls are added (unlike loud plastic trays)
- \* 100 ball capacity

<b>P036</b>
-------------



### Used Range Balls

Need an economical option?  
Grade-A used 2-piece striped range balls  
Supply varies - call for current availability  
300 Per Box

- RS040302** White
- RS040303** Yellow



**GSGD1350**

### Raised Range Ball Storage Box

- \* 45" x 25" x 32"H
- \* Shown in black

**GSGD1350**



**GSGD1148**

### Medium Range Ball Storage Box

- \* 48" x 18" x 18"H
- \* Not routed
- \* Shown in green

**GSGD1148**

### Large Range Ball Storage Box

- \* 60" x 18" x 18"H
- \* Not routed
- \* Not shown

**GSGD1160**



**GSGB150**



**GSGB250**

### Deluxe Range Ball Crate

Dress up your driving range with our new Deluxe Range Ball Crate. With three sizes, these crates will give your range a sophisticated look. Made from the same material as our Recycled Bag Stands to complete your range.

- \* includes powder coated sliding door
- \* Stackable
- \* Shown in brown with optional HPL logo

- GSGB150** 12" x 10" x 9"
- GSGB250** 20" x 10" x 9"
- GSGB350** 20" x 15" x 9"



**GSGB350**

**All Storage Boxes are structural to handle the weight of the range balls.**

See Recycled Plastics Catalogue on our website for colour options



### Complete Ball/Trash Stations

Completely customizable with any of our interchangeable ensemble components. Mix and match colors, towels, can lids, ball washers and more!

See pages 168 - 175 to complete your station!



BY650



BY690-3

### Aluminum Club Washer Parts

**BY690-5** Neoprene Rubber Stopper

**BY690-6** Neo-Nylon cover gasket

**BY650** Flanged Base

**BY690-3** Two brushes per Club Washer. Sold individually. Available for 2022.



BY718T



BY718

### Detergent

Our detergents leave balls sparkling clean and remove the residue in the ball or club washer. 450 tablets/container. One tablet per ball or club washer fill. 4L container. Mix 1 part concentrate to 4 parts water

**BY718T** 450 tablets/container

**BY718** 4L container

See Recycled Plastics Catalogue on our website for colour options



BY700

### Plunger Style Ball Washer

All of our ball washers are proudly made in North America. They consist of cast-in-mold aluminum alloy and feature durable polymer and stainless steel internal components, providing years of trouble free service. Our standard ball washer.

Capacity: 7.2 US Pints  
Cleans 1 ball at a time.

**BY700**



BY770

### Custom Plunger Style Washer

Manufactured to the same standards as the 700 ball washer, the 770 model can be customized with a logo.

Min order is 9 (18 for copper vein)

Capacity: 7.2 US Pints  
Cleans 1 ball at a time.

**BY770**



BY778

### Crank Style Ball Washer

Industry exclusive

Easy lift cover with hinges

Powder coated color finish (glass hard) ensures durable and beautiful color for years Unique brush style cleans more than one ball at a time. Features new handle designs!

Manufactured to the same standards as the plunger style ball washers, the crank style model is able to clean multiple balls at a time.

Capacity: 7.2 US Pints  
Cleans 4 balls at a time.

**BY778**



- Green
- Red
- Black
- Copper Vein





### Plunger Style Ball Washer Repair Kit

Includes all parts listed bellow (also sold separately).

<b>BY716AS</b>	<b>Snap Hook Assembly</b>
<b>BY717</b>	<b>Rubber Drain Plug Gasket</b>
<b>BY714</b>	<b>Drain Plus Wrench</b>
<b>BY713</b>	<b>Drain Plug</b>
<b>BY714-1</b>	<b>Allen Keys (5/32" Cal.)</b>
<b>BY714-2</b>	<b>Allen Keys (3/16" Cal.)</b>
<b>BY712AS</b>	<b>Brush Assembly</b>
<b>BY71AAS</b>	<b>Agitator Assembly</b>



### Crank Style Repair Kit

Includes all parts listed bellow (also sold separately).

<b>BY779KIT</b>	<b>Brush Holder Assembly</b>
<b>BY777-3</b>	<b>Complete Handle</b>
<b>BY777-4</b>	<b>Complete Handle * shown in new style</b>



### Ball Washer Stand Base

The stand base made of cast aluminum and has powder coated finish. The Stand Base acts as a universal base unit for all of our ball washer Ensembles.

\*\*Spikes sold separately

<b>BY701G</b>	<b>Green</b>
<b>BY701R</b>	<b>Red</b>
<b>BY701BK</b>	<b>Black</b>
<b>BY701CV</b>	<b>Copper Vein</b>



### Ball Washer Stand Pipes

Stand Pipes are made of aluminum and powder coated black. ID 2 1/8"; OD 2 3/8".

\*Pipes sold separately in black only.

<b>BY702A</b>	<b>34" Stand Pipe for BY701 base</b>
<b>BY04-6A</b>	<b>46" Stand Pipe for direct burial</b>



### Foot Brush w/ Screws

\* Attaches to the 701 base. Sold individually.

<b>BY610</b>	<b>Measures 5.25"x5.75"</b>
--------------	-----------------------------

### Stainless Steel Spikes for BY701 Base

\* Secures the base to the ground. 4" spikes

<b>BY801-3</b>	<b>Sold in sets of three.</b>
----------------	-------------------------------

### Designer Series Litter Bins



Made of strong polyethylene plastic, these litter bins are ergonomically designed to add elegance to both the ball washer ensemble and on their own. Available with three different lid styles to suit your needs.

**BY765**

\* See price list for full selection of lids, mounting brackets and stands.



BY766T

BY766S

BY766C

### Designer Litter Bin Lid Accessories

**BY766T**

Trash Lid Opening

**BY766S**

Solid Lid (no opening)

**BY766C**

Can Lid Opening

\* Lids available only in solid black



BY748A

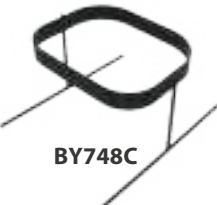

BY748C



BY748B

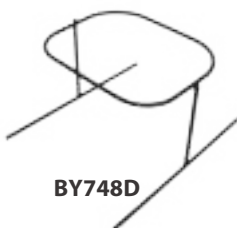

BY748D

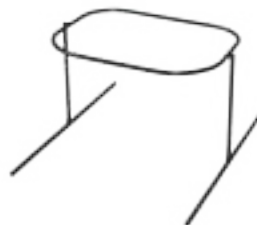

BY747

BY746

### Designer Litter Bin Stand Accessories

**BY748A**

In-ground stand Heavy Duty

**BY748C**

Above ground stand Heavy Duty

**BY748B**

In-ground stand Standard

**BY748D**

Above ground stand Standard

\* All stands are made of aluminum and powder coated black

### Designer Litter Bin Mounting Brackets

**BY747**

Double Mounting Bracket

**BY746**

Single Mounting Bracket

\* All stands are made of aluminum and powder coated black

Matching up a Standard Golf ball washer? We can do that. Call to order today



### 9 - Gallon (34L) Litter Caddie With Spike

9 gallon trash capacity, steel construction, powder coat finish, and spike bottom allows you to locate it anywhere

<b>ST13150</b>	<b>Red</b>
<b>ST13175</b>	<b>Blue</b>
<b>ST13400</b>	<b>Yellow</b>
<b>ST13700</b>	<b>Green</b>
<b>ST13195</b>	<b>Black</b>



### Litter Baskets Bases

<b>BY750-5</b>	<b>Litter Basket wth Spike Base</b>
<b>BY759</b>	<b>Litter Basket with Flat Base</b>
<b>BY760</b>	<b>Litter Basket with Cone Base</b>



### Stand Base Mount

- Attaches to the BY701 base stand page 170

<b>BY745</b>
--------------



### Pipe Mount

- Attaches to the 702A and the 704-6A ball washer stand plpes and fits the BY750 Litter Basket with Spike Base

<b>BY691</b>
--------------



### Dirt Magnet Range & Ball Washer Towels

\* Box of 36

<b>EI061881</b>	<b>Royal Blue</b>
<b>EI061882</b>	<b>Forest Green</b>
<b>EI061883</b>	<b>Milk Chocolate</b>



**BY725**



**BY730BK**

### Traditional Ball Washer Towels

Smooth cotton fibers deliver a light, thin, fast drying fabric. 12 towels/pkg.

<b>BY725</b>	<b>Double Green Towel</b>
--------------	---------------------------

100% cotton with smooth cotton threads producing a very soft feel. 12 towels/pkg.

\* Embroidery available, please contact us.

<b>BY730BK</b>	<b>Elite Black Hand Towel</b>
----------------	-------------------------------



**BY731G**



**BY731BK**

Smooth cotton fibers deliver a light, thin, fast drying fabric. Sold in green and black. 12 towels/pkg.

<b>BY731G</b>	<b>Green Tri-Fold Towel</b>
---------------	-----------------------------

<b>BY731BK</b>	<b>Black Tri-Fold Towel</b>
----------------	-----------------------------



**BY728**



**BY729**

### Corner Grommet Tee Towels

Strong, absorbent, and soft disposable. Corner Grommet Tee Towels. 200 towels/pkg

<b>BY728</b>	<b>Classic Corner Grommet</b>
--------------	-------------------------------

<b>BY729</b>	<b>Premium Corner Grommet</b>
--------------	-------------------------------

Note that many more options are available. See Bayco catalogue on our web site.



### Practice Greens Poles

Made with fiberglass rod, the poles come with plastic or chrome base. Available in Javelin tapered version, as well.

Chrome Base	Plastic Base	
BY272W/CH	BY272W	White Rod
BY272Y/CH	BY272Y	Yellow Rod
BY272/CH	BY272J	Javelin Rod

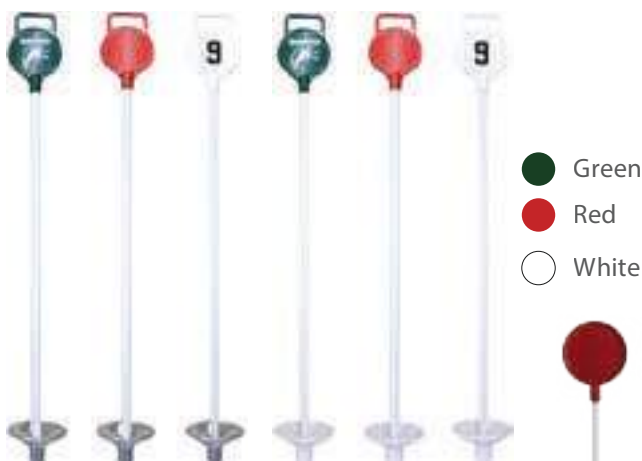

### Gimme Practice Greens Markers

Made with 1/2" thick fiberglass rod and smooth, hard plastic head, with added option for a custom decal of your course logo.

Chrome Base	Plastic Base	
BY264/BLANK/CH	BY264/BLANK	Blank Head
BY264/1-9/CH	BY264/1-9	Set of 1-9
BY264/10-18/CH	BY264/10-18	Set of 10-18
BY264/CUSTOM/CH	BY264/Custom	Custom



BY267/BLANK/R

### Target 3-Arc Practice Greens Markers

Target base does not need a cup. Comes complete with a stainless steel spike.

BY267/BLANK/R

### Practice Green Bases - Chrome and Plastic

Chrome Base	Plastic Base	
BY278-2CH	BY275-2	5/16"
BY278-6CH	BY275-3	3/8"
BY278-7CH	BY275-5	1/2"



### Chipping Greens Ball Pusher

This easy to use ball pusher is perfect for the practice chipping green. It allows golfers to sweep balls quickly and effectively, speeding game time

BY132

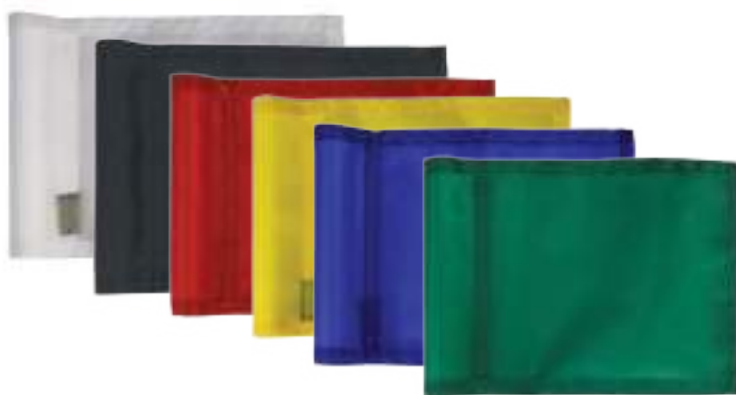

### Plain Practice Green Flag

Made of durable 400 Denier Solar Max material complete with a tube locking attachment

\* 6" x 8" 1/2" tubes

<b>120230</b>	<b>White</b>
<b>120231</b>	<b>Red</b>
<b>120232</b>	<b>Yellow</b>
<b>120233</b>	<b>LT Blue</b>
<b>120235</b>	<b>Black</b>
<b>BY273BLT</b>	<b>Blue</b>

### Checkered Practice Green Flag

Made of double sided Dura material and dye sublimated for added durability. Complete with a tube locking attachment.

\* 6" x 8" 1/2" tubes

<b>120240</b>	<b>Black/White</b>
<b>120241</b>	<b>Black/Yellow</b>
<b>120242</b>	<b>Green/White</b>
<b>120243</b>	<b>Red/White</b>
<b>120244</b>	<b>Blue/White</b>

### Numbered Practice Green Flag

Made of double sided Poplin material and dye sublimated for added durability. Complete with a tube locking attachment.

<b>120246</b>	<b>Red with White Numbers 1-9</b>
<b>120247</b>	<b>Red with Black Numbers 1-9</b>
<b>120248</b>	<b>White with Black Numbers 1-9</b>
<b>120249</b>	<b>Red with White Numbers 10-18</b>

### Canadian Flag

Made of double sided Poplin material and dye sublimated for added durability, making them less vulnerable to fading and eliminating peeling. 1/2"

<b>120236</b>
---------------

### Dye-Sublimated Practice Green Flag

Double sided only

\*Minimums apply, call for quote

\* 1/2" tube

<b>111792</b>
---------------

# STANDARD GOLF COMPANY

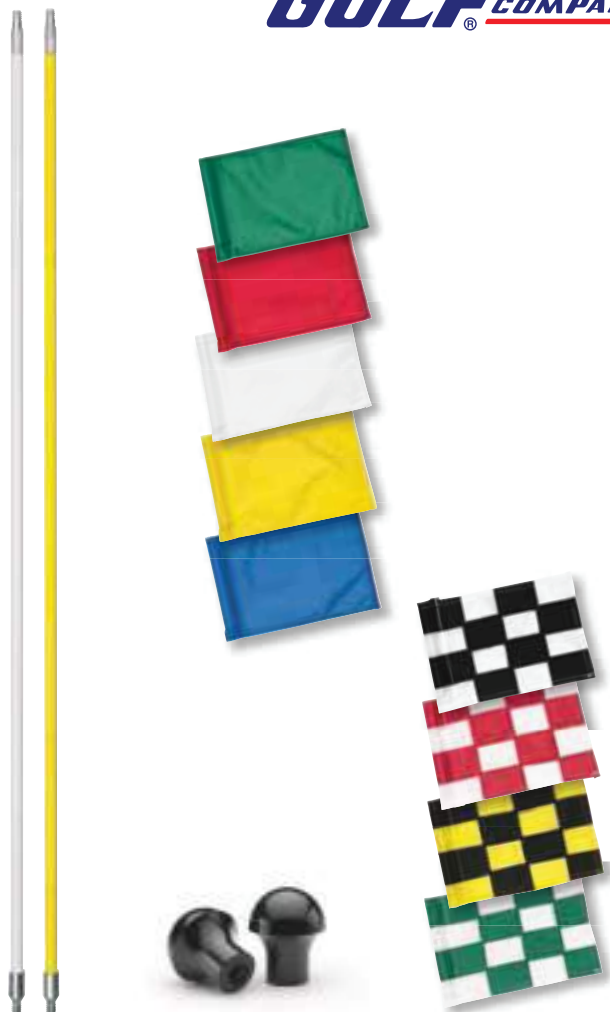

BY255PL



BY252AL

## Practice Green Rods

Solid, resilient fiberglass construction with veil-wrapped coating. 3/8" (1 cm) diameter; 28" (71 cm) long.

Knob, base, flags and heads sold separately.

Fits 3/8" (1 cm) practice green flags only.

\* stocked in white other colours available on special order bases

**ST20382** White

## Plain Flags

**ST20594** Green

**ST20694** Red

**ST20794** White

**ST20894** Yellow

**ST20994** Blue

## Checker Flags

**ST20912** Blk/Wht

**ST20922** Red/Wht

**ST20932** Blk/Yel

**ST20942** Grn/Wht

## Flagstick Knob

**ST20822**

## Cast Aluminum Heads

\* Add your logo or numbers to a set of custom decals

**ST20532** White

**ST20534** Red

## Metal Base

\* Fits 3/8" practice green rods only

**ST20322**

## Practice Green Cups

\* 4 1/4" diameter x 4 1/4" tall

**BY255PL** Plastic Greens Cup

**BY252AL** Aluminum Greens Cup

See Recycled Plastics Catalogue on our website for colour options



BYE803G

### Recycled Plastic Broken Tee Caddy

Made of recycled plastic lumber, this caddy stands 4" tall and has a steel mesh base.

<b>BYE803G</b>	<b>Green</b>
----------------	--------------



BY808G

### Aluminum Broken Tee Caddies

Made of cast aluminum and powder coated. Stainless steel spike included.

<b>BY808R</b>	<b>Red</b>
<b>BY808W</b>	<b>White</b>
<b>BY808B</b>	<b>Blue</b>
<b>BY808Y</b>	<b>Yellow</b>
<b>BY808BK</b>	<b>Black</b>
<b>BY808G</b>	<b>Green</b>



BY815Y

### Plastic Broken Tee Caddy

Made of durable plastic material and color impregnated through allows for an economical and lasting tee caddy. Stainless steel spike included.

<b>BY815R</b>	<b>Red</b>
<b>BY815W</b>	<b>White</b>
<b>BY815B</b>	<b>Blue</b>
<b>BY815Y</b>	<b>Yellow</b>

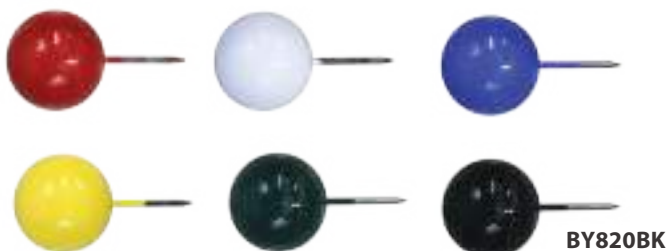

BY820BK

### 3.5" Solid Aluminum Tee Marker

Made of aluminum with powder coated finish. Each marker comes complete with a stainless steel spike.

<b>BY820R</b>	<b>Red</b>
<b>BY820R</b>	<b>White</b>
<b>BY820R</b>	<b>Blue</b>
<b>BY820R</b>	<b>Yellow</b>
<b>BY820G</b>	<b>Green</b>
<b>BY820BK</b>	<b>Black</b>

See Recycled Plastics Catalogue on our website for colour options





### 3" Solid Plastic Tee Marker

Made of durable polyethylene plastic material. Color impregnated for longevity. Each marker is complete with a metal spike.

<b>BY810R</b>	<b>Red</b>
<b>BY810W</b>	<b>White</b>
<b>BY810B</b>	<b>Blue</b>
<b>BY810Y</b>	<b>Yellow</b>



### 5" Solid Plastic Tee Marker

Made of durable polyethylene plastic material. Color impregnated for longevity. Each marker is complete with a metal spike.

<b>BY812R</b>	<b>Red</b>
<b>BY812W</b>	<b>White</b>
<b>BY812B</b>	<b>Blue</b>
<b>BY812Y</b>	<b>Yellow</b>



### 5" Hollow Tee Marker w/ Plastic Base

Our 5" hollow plastic tee marker, but with molded in plastic base.

<b>BY814R</b>	<b>Red</b>
<b>BY814W</b>	<b>White</b>
<b>BY814B</b>	<b>Blue</b>
<b>BY814Y</b>	<b>Yellow</b>
<b>BY814BK</b>	<b>Black</b>

See Recycled Plastics Catalogue on our website for colour options



### 4" Tear Drop Tee Marker

Made of 1/8" thick steel with powder coated finish. Custom decals and colors are available. 4" x 8"

<b>BY816R</b>	<b>Red</b>
<b>BY816W</b>	<b>White</b>
<b>BY816B</b>	<b>Blue</b>
<b>BY816Y</b>	<b>Yellow</b>



### Recycled Plastic Cube Tee Markers

Made of durable polyethylene plastic material. Color impregnated for longevity. Each marker is complete with a metal spike.

<b>BYE800R</b>	<b>Red</b>
<b>BYE800W</b>	<b>White</b>
<b>BYE800B</b>	<b>Blue</b>
<b>BYE800Y</b>	<b>Yellow</b>



### Cast Tee Markers

We offer many more stock and custom tee marker options from Port City Signage. Call your GSH sales representative for more details.

See Recycled Plastics Catalogue on our website for colour options

### Complete Rakes



<b>15" HEAD</b>	<b>LIGHTWEIGHT RAKES</b>	<b>21" HEAD</b>
BY100PD	* Wood Handle 48"	BY125YE
BY118G	* Green Fiberglass Handle 51"	BY125G
BY118BYE	* Yellow Fiberglass Handle 51"	BY126YE
<b>15" HEAD</b>	<b>OCTAGON RAKES</b>	<b>21" HEAD</b>
BY150GR	* Green Fiberglass Handle 51"	BY166GR
BY150YE	* Yellow Fiberglass Handle 51"	BY166
BY15072G	* Green Fiberglass Handle 72"	BY165
BY150YE/72	* Yellow Fiberglass Handle 72"	BY165
BY150GR/CART	* Green Cart Handle 42"	BY166

<b>15" HEAD</b>	<b>DISC TOOTH RAKE</b>
BY160GR	* Green Fiberglass Handle 51"
BY160YE	* Yellow Fiberglass Handle 51"
BY16072G	* Green Fiberglass Handle 72"
BY160YE/72	* Yellow Fiberglass Handle 72"
BY156GR/CART	* Green Cart Handle 42"

### Rake Heads

Our rake heads are made of durable, lightweight plastic that is easy to use and carry. They spread sand evenly, leaving a consistent playing surface with minimal difference in grooves.

<b>15" HEAD</b>	<b>21" HEAD</b>
BY105	BY102
BY151BK	BY164BK
<b>16" HEAD</b>	
BY161	* Disc Tooth Rake Head

### Rake Handles



BY106	* Yellow Wood Handle 48"
BY154	* Green Fiberglass Handle 51"
BY152G-72	* Green Fiberglass Handle 72"
BY152	* Yellow Fiberglass Handle 51"
BY152Y-72	* Yellow Fiberglass Handle 72"
BY155	* Green Cart Fiberglass Handle 42"

### Shrink Guard for Rake Handles



<b>125' ROLL</b>	<b>250' ROLL</b>
BY400BK125	BY140BK250
BY140GR125	BY140GR250
BY140YE125	BY140YE250

- \* Black (shown 125' roll)
- \* Green
- \* Yellow



BY234P



BY234P-KIT



BY234R



BY234H



BY234RH



BY234R-1



BY234H-3



BY245



BY780

### Sand & Seed Tube

A slimmer solution with an air tight lid that pops on and off for easier refill and a clip which allows it to snap onto any golf bag. 12.75" H x 2" diameter 0.5 L capacity

**BY234P**

**Personal Sand & Seed Bottle**

**BY234P-KIT**

**Replacement bottom cap, top lid and clip**

### Sand & Seed Bottle

Our sand and seed bottles have a screw on/off bottom lid with wide opening for easy filling. Made of heavy duty plastic. Ergonomically designed for easy transportation and with narrower base, these bottles fit in any bottle holder. 1.3 L capacity

**BY234R**

**Rattle Proof Sand & Seed Bottle**

**BY234H**

**Aluminum Handle 1.3L Capacity**

### Rattle Proof Bottle Molded Handle

Made to the same standard as all of our sand and seed bottles, this bottle is complete with a molded in handle.

**BY234RH**

**1.3L Capacity; Built-in handle**

### Sand & Seed Replacement Parts

**BY234H-1**

**Aluminum handle**

**BY234H-2**

**Vinyl handle cover**

**BY234H-3**

**Replacement Flat Cap**

**BY234R-1**

**Replacement Rattle Proof Cap**

### Sand & Seed Bottle Accessories

Attach the Sand & Seed bottles to virtually any cart.

**BY245**

**Bottle holder for flat bottom**

**BY245U**

**Rattle proof bottom**

**BY245YA**

**Yamaha Carts**

**BY245EZ**

**E-Z-Go Carts**

**BY245CC**

**Club Car Carts**

### Sand & Seed Bottle Cart

Modular golf bag rack made of durable heavy duty metal with powder coated finish.

They can be assembled to any length in multiples of 3', or be set back to back. Sold as a pack of two racks, holds up to 6 golf bags. All necessary hardware included

**BY780BK**

**Double**

**BY780BK-1**

**Single**



BY282G

BY281

### Igloo Water Cooler and Accessories

ABS construction. Ultratherm insulation. Long-lasting, thirst-quenching performance. Includes mounting bracket for cup holder.

**BY281** 5 Gal 10"D (25.4 cm) 17"H (43 cm)

**BY282G** 10 Gal 16 ½"D (41.9 cm) 23"H (58 cm)

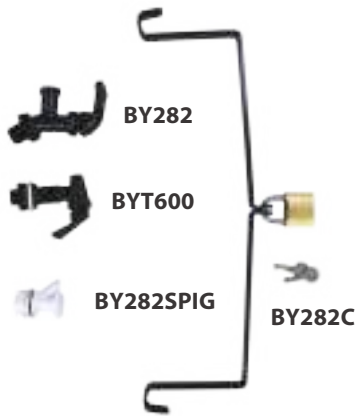

BY282

BYT600

BY282SPIG

BY282C

- BY282C** Lock and Key
- BY282** Lever Style Spigot
- BYT600** Pinch Tube Spigot
- BY282SPIG** Push Button Spigot



BY282CLIP

BY279-4

- BY282CLIP** Plastic Bracket
- BY279-4** Steel Bracket



BY283 BY283P BY288

- BY283** Steel Cup Dispenser
- BY283P** Plastic cup Dispenser
- BY288** 4 oz Solo Cups



### Polypropylene Braided Ropes

Traffic control is a breeze with this 1/4" diameter braided rope. Made of durable polypropylene material, this braided rope is waterproof and resists rot, oil and other chemicals. Hollow braid is super flexible with a smooth diamond weave. Length: 1000 ft spools

<b>BY287</b>	<b>Yellow Rope</b>
<b>BY287GR/WH</b>	<b>Green/White Rope</b>
<b>BY287HG</b>	<b>Green Rope</b>
<b>BY287BK</b>	<b>Black Rope</b>



### Bungee Rope

Made of quality flexible material that maintains elasticity even in cold climates and prevents the pulling out of the stakes if encountered. The rope remains taut and will not sag. Bungee is available in 250 and 500 foot rolls

<b>BY400-250BK</b>	<b>Black</b>
<b>BY400-250YEL</b>	<b>Yellow</b>
<b>BY400-250GN</b>	<b>Green</b>
<b>BY400-250HG/WH</b>	<b>Green/White</b>
<b>BY400-500BK</b>	<b>Black</b>

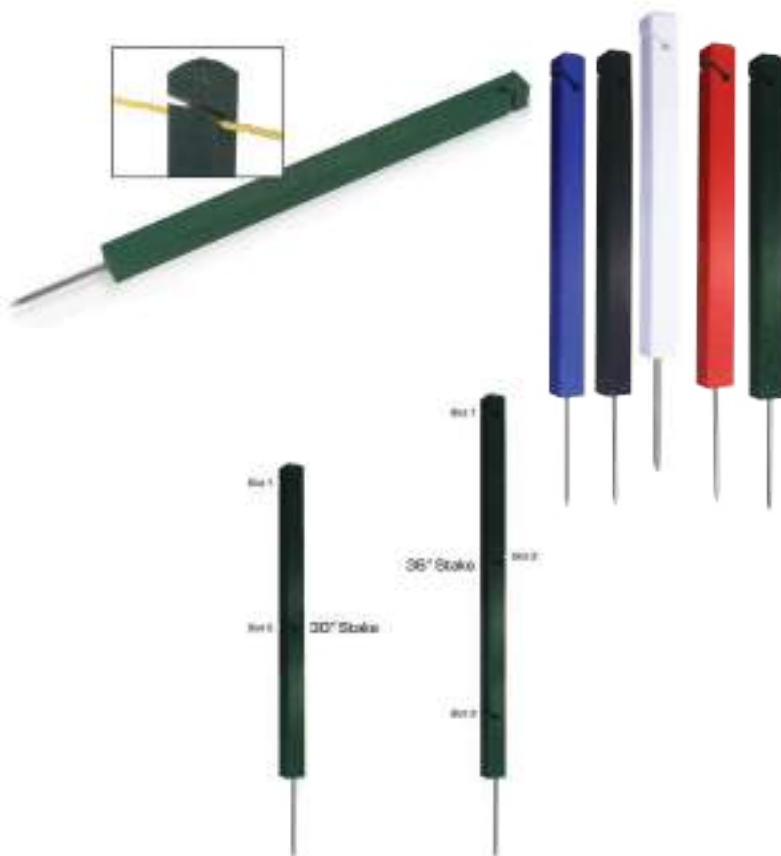

### Rope Stakes

Made of recycled color impregnated plastic with stainless steel spike. 1.5" square Available in 15", 18", 24"

<b>BY289-15</b>	<b>Green 15" with Speed Slot &amp; Bevel</b>
<b>BY289-15BK</b>	<b>Black 15" with Speed Slot &amp; Bevel</b>
<b>BY289BL-15</b>	<b>Blue 15" with Speed Slot &amp; Bevel</b>
<b>BY289RE-15</b>	<b>Red 15" with Speed Slot &amp; Bevel</b>
<b>BY289WH-15</b>	<b>White 15" with Speed Slot &amp; Bevel</b>
<b>BY289BL-18</b>	<b>Blue 18" with Speed Slot &amp; Bevel</b>
<b>BY289RE-18</b>	<b>Red 18" with Speed Slot &amp; Bevel</b>
<b>BY289WH-18</b>	<b>White 18" with Speed Slot &amp; Bevel</b>
<b>BY289BL-24</b>	<b>Blue 24" with Speed Slot &amp; Bevel</b>
<b>BY289RE-24</b>	<b>Red 24" with Speed Slot &amp; Bevel</b>
<b>BY289WH-24</b>	<b>White 24" with Speed Slot &amp; Bevel</b>

**Custom sizes available upon request**



### Rust-Oleum Marking Paint

Rust-Oleum Precision Line marking paint for easy-to-read, bright, vivid markings with no mess. Marks more linear feet than other brands.

Sold by case of 12

<b>BY271WH</b>	<b>White</b>
<b>BY271YE</b>	<b>High Visibility Yellow</b>
<b>BY271RE</b>	<b>Safety Red</b>
<b>BY271OR</b>	<b>Alert Orange</b>
<b>BY271BL</b>	<b>Caution Blue</b>
<b>BY271GR</b>	<b>Green</b>



### Paint And Marking Tools

No more bending, simply insert the turf paint in the wand, point towards the ground and start walking. The wheel on the bottom allows for smooth glide without stopping or jerking. Applying straight lines has never been easier!

<b>BY269</b>	<b>Marking Pistol</b>
<b>BY268</b>	<b>Marking Wand</b>



### Colour Flex Markers

The ColorFlex Fairway Distance Marker is an industry exclusive item that was designed to eliminate the removal of markers while mowing - one of the most bothersome tasks for superintendents. Speed up your mowing times by simply mowing over them.

<b>BY299W</b>	<b>White</b>
<b>BY299Y</b>	<b>Yellow</b>
<b>BY299B</b>	<b>Blue</b>
<b>BY299G</b>	<b>Green</b>
<b>BY299O</b>	<b>Orange</b>
<b>BY299R</b>	<b>Red</b>

### Replacement Markers

<b>BY299-01</b>	<b>Available in colour above</b>
-----------------	----------------------------------

### Installation Kit

<b>BY299KIT</b>
-----------------

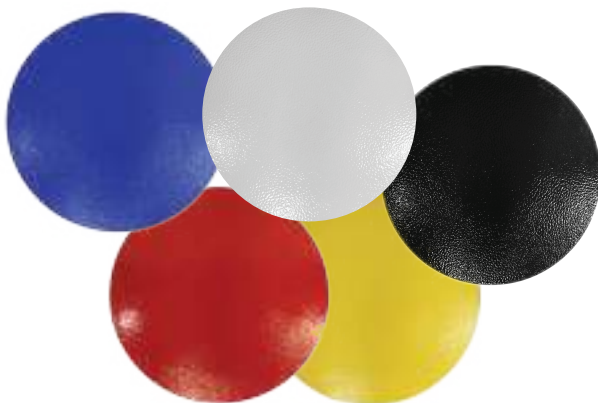

### Domed Aluminum Distance Marker

Cast aluminum distance marker with a powder coated finish. Comes complete with a 6" stainless steel spike.

<b>BY573B</b>	<b>Blue</b>
<b>BY573R</b>	<b>Red</b>
<b>BY573W</b>	<b>White</b>
<b>BY573Y</b>	<b>Yellow</b>
<b>BY573BK</b>	<b>Black</b>



### Domed Polymer Distance Marker

Made of heavy duty polymer, these domed distance markers come complete with a 6" stainless steel spike.

<b>BY571B</b>	<b>Blue</b>
<b>BY571R</b>	<b>Red</b>
<b>BY571W</b>	<b>White</b>
<b>BY571Y</b>	<b>Yellow</b>
<b>BY571BK</b>	<b>Black</b>

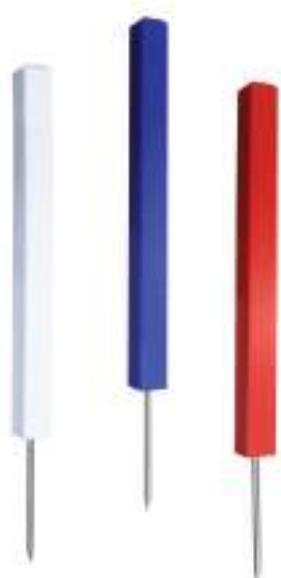

### Recycled Plastic Hazard Marker

Appropriately color coded for OB (white) & water (red) hazards to reference areas on the golf course. Can also be used as distance markers. Size: 24"

<b>BY296B</b>	<b>Blue</b>
<b>BY296R</b>	<b>Red</b>
<b>BY296W</b>	<b>White</b>





### Flagpole Accessories

Kit includes a holder, a Canadian 14x20" Regulation flag; an acorn nut and top bushing; and a 3' white regulation pole. No ferrule required. Flag pole holder mounts directly to your choice of surface (wall, ground or other).

- BY345
- BY345CAN



### Cease Fire Cigarette Butt Stand

Collects unsightly cigarette butts and reduces fire hazard. Made of flame retardant, sturdy polyethylene. Won't rust, dent or crack. Simply lift off the lid to empty the large galvanized steel pail inside.

- BY215GREY Grey



### Aluminum Liners

Cease Fire Liners (sold separately)

- BY215RL Pack of 10



### E-Z Litter Stick

A 12 prong litter stick with a quick release trigger. Made with durable aluminum handle and hard, heavy duty plastic.

- BYEZL3612

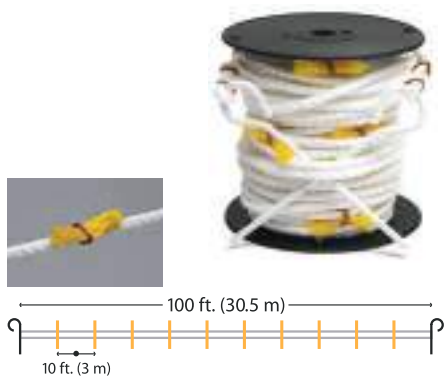

### Range Alignment Rope

\* Set up the range in seconds.  
 \* 10 equidistant markers help you evenly space range dividers and place bag stands.  
 Each spool carries 100' (30.5 m) of rope. Markers — spaced every 10' (3 m) — show you just where to place range dividers 5/16" twisted polypropylene rope

**ST36700**



### Range Flags Plain 18" x 26"

Our range flags are made from heavy duty 400D, UV Treated Nylon, with reinforced corner stitching for a long life.

<b>111641</b>	<b>Red</b>
<b>111642</b>	<b>White</b>
<b>111643</b>	<b>Blue</b>
<b>111644</b>	<b>Yellow</b>
<b>111645</b>	<b>Green</b>
<b>111646</b>	<b>Black</b>
<b>111647</b>	<b>Orange</b>



### Aluminum Range Clubs

Rugged cast aluminum, one piece head construction.

Right	Left
<b>AC031190 - Men</b>	<b>AC031192 - Men</b>
<b>AC031194 - Women</b>	<b>AC031196 - Women</b>
<b>AC031198 - Junior</b>	<b>AC031199 - Junior</b>



### TeeTargets

Give your customers a target to help with their short game. Sturdy Polybutylene frame with Heavy Duty UV Protected nylon netting. • The base is weighted for stability in the wind

<b>TeeTarget3</b>	<b>3' TeeTarget</b>
<b>TeeTargetPad3</b>	<b>3' TeeTarget Accent Pads (6 per pack)</b>
<b>TeeTarget4</b>	<b>4' TeeTarget</b>
<b>TeeTargetPad4</b>	<b>4' TeeTarget Accent Pads (6per pack)</b>
<b>TeeTarget6</b>	<b>6' TeeTarget</b>
<b>TeeTargetPad6</b>	<b>6' TeeTarget Accent Pads (10 per pack)</b>



### Two-Piece Range Marking Pole

Give your range a unique look with these highly visible striped Range Marking Poles. Features two 40" (102 cm) pieces, shipped apart for ease of shipping, 3 1/2" (8.9 cm) diameter PVC pipe. UV resistant paint for superior durability and easy target acquisition. 12" (31 cm) Ground Anchor holds it firmly in place

<b>ST09650</b>	<b>Black/White</b>
<b>ST09660</b>	<b>Blue/White</b>
<b>ST09670</b>	<b>Green/White</b>
<b>ST09680</b>	<b>Red/White</b>
<b>ST09698</b>	<b>Special Color Stripe</b>
<b>ST09790</b>	<b>Ground Anchor 12" (31 cm) high</b>

### Plastic Vertical Yardage Markers

Made from two tone 1/2" solid plastic. The numbers are routed down in the face. Each sign comes pre-drilled, hardware and posts not included. There are many stock colours available. This item is made to order. Please specify your colour and number requirements when ordering.

Colour choices include green/white, white/green, blue/white, black/white, red/white and black/yellow.



	12" x 36"	12" x 48"	18" x 48"
100 yard	<b>GSD1236-100</b>	<b>GSD1248-100</b>	<b>GSD1848-100</b>
150 yard	<b>GSD1236-150</b>	<b>GSD1248-150</b>	<b>GSD1848-150</b>
200 yard	<b>GSD1236-200</b>	<b>GSD1248-200</b>	<b>GSD1848-200</b>
250 yard	<b>GSH1236-250</b>	<b>GSD1248-250</b>	<b>GSD1848-250</b>



### Bayco Nylon Range Banners

Range Banners made of heavy duty dye-sublimated (no peeling) polyester and durable PVC pipe. Available in a full unit, banner only, or framing kit only Numbered 50-300 in 25 yard increments. Some assemblance required.

YARDAGE	BANNER ONLY		BANNER AND FRAME	
	VERTICAL	HORIZONTAL	VERTICAL	HORIZONTAL
50 YDS	<b>BYVRB050</b>	<b>BYRB050</b>	<b>BYCOMVRB050</b>	<b>BYCOMRB050</b>
75 YDS	<b>BYVRB075</b>	<b>BYRB075</b>	<b>BYCOMVRB075</b>	<b>BYCOMRB075</b>
100 YDS	<b>BYVRB100</b>	<b>BYRB100</b>	<b>BYCOMVVR100</b>	<b>BYCOMRB100</b>
125 YDS	<b>BYVRB125</b>	<b>BYRB125</b>	<b>BYCOMVVR125</b>	<b>BYCOMRB125</b>
150 YDS	<b>BYVRB150</b>	<b>BYRB150</b>	<b>BYCOMVVR150</b>	<b>BYCOMRB150</b>
175 YDS	<b>BYVRB175</b>	<b>BYRB175</b>	<b>BYCOMVVR175</b>	<b>BYCOMRB175</b>
200 YDS	<b>BYVRB200</b>	<b>BYRB200</b>	<b>BYCOMVVR200</b>	<b>BYCOMRB200</b>
225 YDS	<b>BYVRB225</b>	<b>BYRB225</b>	<b>BYCOMVVR225</b>	<b>BYCOMRB225</b>
250 YDS	<b>BYVRB250</b>	<b>BYRB250</b>	<b>BYCOMVVR250</b>	<b>BYCOMRB250</b>
275 YDS	<b>BYVRB275</b>	<b>BYRB275</b>	<b>BYCOMVVR275</b>	<b>BYCOMRB275</b>
300 YDS	<b>BYVRB300</b>	<b>BYRB300</b>	<b>BYCOMVVR300</b>	<b>BYCOMRB300</b>

<b>BYRBKIT</b>	<b>Range Banner Frame Only Kit</b>
----------------	------------------------------------



Large Bi level brushes that gently scrub oversized woods, irons, and grips.

### Bayco Range Club Washer

- \* Heavy-duty polyethylene body & cover. Comes with two 12" x 12" bristle brushes that can be rotated for maximum utilization.
- \* Handles on either side for lifting & moving. Cover has 6" opening for easy access. No wires, clamps or screws required.
- \* Will not lift during use.
- \* 15" x 21" h
- \* Opening is 6"

- BY695BK** Black
- BY695** Green
- BY405** Replacement Brush \* Two required for each washer 12" x 12" x 2 1/2"



### Range Mate Club Washer Brushes

- \* Replaceable brushes that can be reversed to extend their usefulness.
- \* Sold individually. Each club washer requires 2 brushes.

- ST01602** Replacement Brush (2 Required)



### Tube Style Metal Mesh Range Divider

- \* Durable steel tube construction
- \* Zinc coated then painted to resist corrosion
- \* Shown with optional bag stand
- \* 59" x 33 1/2" x 13 3/4"

- PGTD003**
- PGTD005** Optional bag stand available



BY780-1

### Modular Bag Rack

Modular golf bag rack made of durable heavy duty metal with powder coated finish. They can be assembled to any length in multiples of 3', or be set back to back. Sold as a pack of two racks, holds up to 6 golf bags. All necessary hardware included

- BY780** Double sided not shown
- BY780-1** Single sided

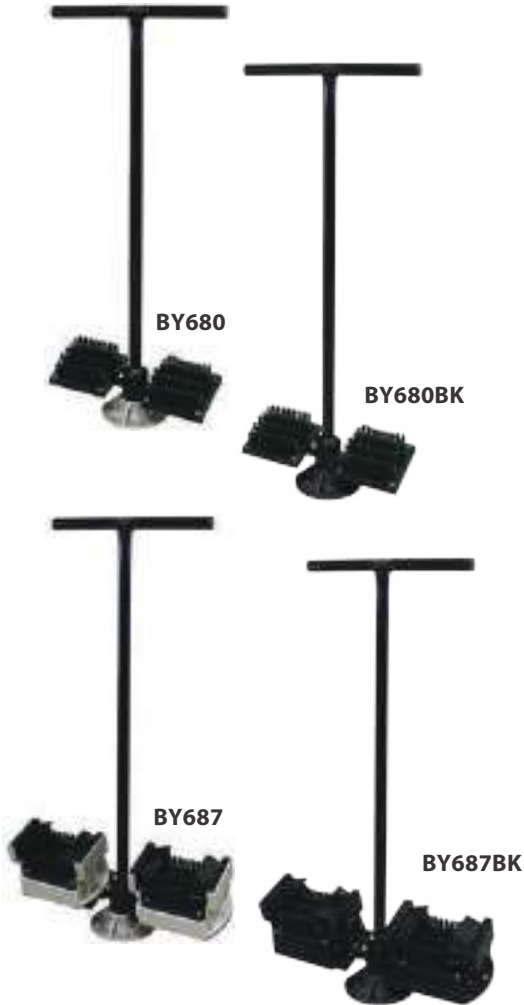

### Bayco Spike Cleaners

Stands are constructed of 1" steel tubing with flange base. The base can be secured to a hard surface with lag bolts or onto grass or other ground surface with four 6" long spikes (all necessary hardware is provided).

\* Also available in solid black for a small upcharge - see price list

- BY680** Double Spike Brush Stand
- BY680BK** Double Spike Brush Stand black flange

- BY687** Double Spike Brush Stand with Side Brushes
- BY687BK** Double Spike Brush Stand black flange with Side Brushes

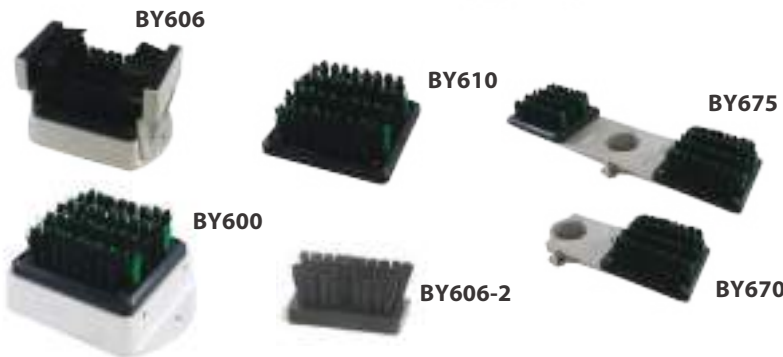

### Replacement Spike Brush

\* 5 3/8" x 5 1/8"

- BY606** Brush assembly with side brushes
- BY600** Replacement brush assembly
- BY605** Replacement holder only
- BY606-2** Replacement Side Brush
- BY610** Replacement Base Brush for BY701
- BY675** Replacement double mount with brushes
- BY670** Replacement single mount brush



### Duo-Kleener Stand

Put this useful spike cleaner to work wherever it's needed most. Anchors in asphalt or in the ground with turf stakes. Includes stand, brushes, hardware and three 3 1/2" (9cm) spikes.

Note: This unit does not have to be mounted to be stable and can be moved easily to different locations as needed

- ST36650** Duo-Kleener Stand
- ST14252** Replacement Brush



### Solid Tube Flags

All of our course flags are made of durable, quality, 400 Denier Solar Max material\* complete with a tube locking attachment 14" x 20"

<b>111740</b>	<b>Orange</b>
<b>111741</b>	<b>Red</b>
<b>111742</b>	<b>White</b>
<b>111743</b>	<b>Blue</b>
<b>111744</b>	<b>Yellow</b>
<b>111745</b>	<b>Green</b>
<b>111750</b>	<b>Black</b>

### Checkered Tube Flag

Our checkered flags are made of Dura material and are dye sublimated. Complete with a tube locking attachment.

<b>BY1005BL/WH-CHT</b>	<b>Blue/White</b>
<b>BY1005GR/WH-CHT</b>	<b>Green/White</b>
<b>BY1005RE/WH-CHT</b>	<b>Red/White</b>
<b>BY1005WH/BK-CHT</b>	<b>White/Black</b>
<b>BY1005YE/BK-CHT</b>	<b>Yellow/Black</b>
<b>BY1005YE/WH-CHT</b>	<b>Yellow/White</b>

### Numbered Tube Flags

Our checkered flags are made of poplin material and are dye sublimated\*. Complete with a tube locking attachment.

Numbered 1-9		Numbered 10-18	
<b>111761</b>	<b>White w/ Red #s</b>	<b>111762</b>	
<b>111763</b>	<b>Yellow w/ Black #s</b>	<b>111764</b>	
<b>111765</b>	<b>Red w/ White #s</b>	<b>111766</b>	
<b>111769</b>	<b>Blue w/ White #s</b>	<b>111770</b>	



### Canada Pin Flag

Made of Double Sided Poplin material. It is dye sublimated for added durability, making them less vulnerable to fading and eliminating peeling. They come complete with a tube locking attachment. American flag also available upon request

<b>G90012CAN</b>	<b>12" x 18" - Nylon</b>
------------------	--------------------------



### Special Event Tube Flags

Choose between a Cancer Awareness and Superintendent's Revenge flags in our specialty Double Sided Poplin material. Completed with tube attachment. These flags are in stock and available for immediate shipping.

<b>BY1005REVT</b>	<b>Superintendent's Revenge</b>
<b>BY1005REVT</b>	<b>Awareness Flag</b>



### Dye-Sublimated Flags

Dye sublimation uses solid dyes under heat & pressure to produce photo-lab-quality images on fabric. Colour is absorbed directly into the material, making it more durable and less vulnerable to fading than other prints. Your dye sublimated fabric can even be washed in a household washing machine!

Best of all, if you run your fingers over the surface of a sublimated fabric, you will feel nothing other than the fabric itself! Unlimited Colour/Combinations - one great price!

- \* Multiple logos per flag
  - \* Each flag can have its own different logo
  - \* Text or hole numbers can be added to each flag for no extra cost!
- No set up or art charges with good quality artwork: High resolution Vector format. Most common file include .ai, .eps and .pdf. \* 9 flag minimum \* quantity breaks on 18+ flags

#### Double Sided

Poplin Flags with Blocker for 2 sided Dye

- \* Excellent medium for heavy graphics or two sided graphics
- \* An optional blocker can be added to allow no show through from back to front.
- \* Heaviest of the options especially when a blocker is added, this tri-layer flag needs wind to move.

111798

#### Single Sided

Dura Flag:

- \* Single sided dyed and approx. 95% show through to the other side
- \* Very stable fabric in medium to strong wind due to the fact that the fabric is porous and allows some wind to move.

Poly Silk Flutter Flags:

- \* Single side dye that has 98% show through to the other side.
- \* Very lightweight. Works great in low breeze or cross breeze settings.
- \* Great in arid or semi arid environment as it is always fluttering even in a 1 mph breeze.
- \* Very quick drying if wet, dries within minutes of the rain stopping

111796

#### Practice Greens

Poplin Flags with Blocker for 2 sided Dye

- \* 1/2" tubes for the Bayco practice sticks
- \* Double sided option only

111792

### Embroidered Flags

Embroidered flags are all done locally, providing our customers with quick turnaround times. Add your embroidered club or tournament logo to any of our nylon flags. Simply provide us with a full colour copy of your logo and layout.

- \* Embroidered with UV-resistant threads
- \* Minimum order is 9 flags
- \* Digitizing fees will apply if required

Flags are standard on a tube. Specify if required with grommets or Soft Pocket style.

141401

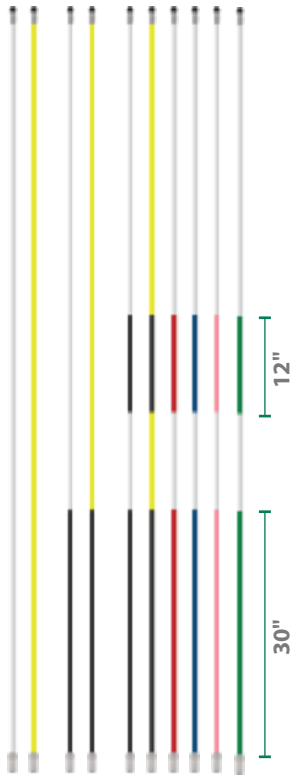

- White Pole
- Yellow Pole
- White Pole with 1 Black Stripe
- Yellow Pole with 1 Black Stripe
- White Pole with 2 Black Stripes
- Yellow Pole with 2 Black Stripes
- White Pole with 2 Red Stripes
- White Pole with 2 Blue Stripes
- White Pole with 2 Pink Stripes
- White Pole with 2 Green Stripes

	5'	7'	7.5'	8'
White Pole	BY300W-5	BY300W-7	BY300W-75	BY300W-8
Yellow Pole	BY300Y-5	BY300Y-7	BY300Y-75	BY300Y-8
White Pole with 1 Black Stripe		BY300BW-71	BY300BW-751	BY300BW-81
Yellow Pole with 1 Black Stripe		BY300YB-71	BY300YB-751	BY300YB-81
White Pole with 2 Black Stripes			BY300BW-752	
Yellow Pole with 2 Black Stripes			BY300YB-752	
White Pole with 2 Red Stripes			BY300RW-751	
White Pole with 2 Blue Stripes			BY300BLW-751	
White Pole with 2 Pink Stripes			BY300PW-751	
White Pole with 2 Green Stripes			BY300GW-751	

### Regulation Flag Poles BY300

Bayco Golf regulation fiberglass poles are manufactured to the highest quality and appearance for excellent corrosion and weather ability. The regulation poles are 1/2" thick and come in variety of sizes and colors/stripes. They are veil wrapped to increase lifespan and reduce splinters from fiberglass material. Every flag pole is top threaded and color impregnated throughout which means that the color will not peel off or fade with time. The flag poles are completed with a smooth ferrule (you may replace it with a slotted [308STD] or locking [308B\*] ferrule), and with a top acorn nut that will suit the swivel for grommet style flags or tube style flags. When shipped, we add a sleeve on bushing and ferrule for additional protection.

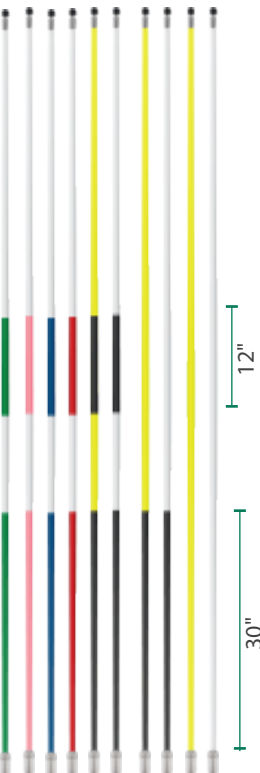

- White Pole
- Yellow Pole
- White with 1 Black Stripe
- Yellow with 1 Black Stripe
- White with 2 Black Stripes
- Yellow with 2 Black Stripes
- White with 2 Red Stripes
- White with 2 Blue Stripes
- White with 2 Pink Stripes
- White with 2 Green Stripes

	7'	7.5'	8'	10'
White Pole	BY300TW-7	BY300TW-75	BY300TW-8	BY300TW-10
Yellow Pole	BY300TY-7	BY300TY-75	BY300TY-8	BY300TY-10
White with 1 Black Stripe	BY300TBW-71	BY300TBW-751	BY300TBW-81	
Yellow with 1 Black Stripe	BY300TBY-71	BY300TBY-751	BY300TBY-81	
White with 2 Black Stripes		BY300TBW-752		
Yellow with 2 Black Stripes		BY300TBY-752		
White with 2 Red Stripes		BY300TRW-752		
White with 2 Blue Stripes		BY300TBLW-752		
White with 2 Pink Stripes		BY300TPW-752		
White with 2 Green Stripes		BY300TGW-752		

### Tournament Flag Poles BY300T

Bayco Golf tournament fiberglass poles are manufactured to the same standards as the regulation poles. They are 3/4" thick in the middle and are tapered, making them stronger and more wind resilient. They also come in variety of sizes and colors/stripes and can reach up to 10' in length. Like the regulation poles, the tournament poles are veil wrapped, top threaded and color impregnated ensuring their longevity. The flag poles are completed with a smooth ferrule (you may replace it with a slotted [BY308STD] or locking [BY308B\*] ferrule), and with a top acorn nut that will suit the swivel for grommet style flags or tube style flags. When shipped, we add a sleeve on bushing and ferrule for additional protection.





BYSS300

BY3SS300T

### Smart Stick Poles

Six eye prism flag sticks bring 100% reflection coverage making those poles hotter, faster, and more accurate for all range finders. The prism reflectors are integrated into the pole itself. Length: 7.5'  
Other colors and striping is available.

**BYSS300**

**BY3SS300T**



### Smarty Reflector

Easy to screw on top of any flag stick. Made with brass bushing to avoid premature wear of the threads. Sold individually.

**BY304-6B**

**Six Eyed**



### Elite Laser Reflector

Easy to screw on top of any flag stick. Made of specially formulated, soft polyurethane cylinder protects greens from flag swivel denting when dropped. Sold individually.

**BY303-ELITE**



### Bayco Laser Reflectors

Full 360° visibility, no dead spots, made of highly reflective material with a large surface area. Made for both regulation and tournament poles. Sold individually or in sets of 9.

**BY3012**

**1/2" Opening**

**BY3034**

**1/4" Opening**



### Quick Click

Removes the need for tools to change the flags. Works only with Bayco Tube Flags. Sold as sets of 9

**BY316PL-9**

### Security Nut

Secures flags onto flag poles and theft. Slim enough to be used with or without the Acorn Nut.

**BY1005NUT**

### Acorn Nut

**BY1005-3BK**



### Bayco Ferrules

**BY308**

**Smooth Ferrule**

**BY308STD**

**Slotted Ferrule**

**BY308B**

**Locking Ferrule**

\* Locking ferrule only works with Pro Hole cups BY253AL



### Mully Cup Lifter

An easy to install ball lifter. Reduces bending and golfer-pole interaction. No need to remove the ferrule upon installation. 360° ball entrance with no interference. Fits regulation (1/2") and tournament (3/4") poles. All necessary hardware included.

**BY319-01**



### Golf Ball Tender

Completely flexible, stain resistant plastic golf ball tender. Simply place it onto the flag pole, no need to remove the ferrule. It allows the golfer to lift the ball by lifting the flag pole, reducing bending. Sold in sets of 18 or individually.

**BY309**

# STANDARD GOLF<sup>®</sup> COMPANY



The flagsticks are available on special order in many different colours  
- call for details



## Royaline Poles

Ultra-strong, resilient, solid fiberglass construction. 1/2" diameter from top to bottom.

113399 -1

White 5'

113510

White 7.5'

113520

Yellow 7.5'

## Tournament Style 7.5' Poles

Extra left in the center for added wind resistance and performance on the greens. 1/2" diameter at tip and ferrule, 3/4" in centre.

113600

White 7.5"

113610

Yellow 7.5"



ST18333



ST18222



ST18444



ST26512

## ST2000 Smart-Fit Cups

**Standard Golf's flagsticks come with Smart-Fit ferrule. For best results, use one of these matching cups only:**

The popular ST2000 Smart-Fit Cup has a third configuration. A "hybrid", with an aluminum base and plastic molded walls, combines the best of our aluminum and plastic ST2000 models. Notched-ferrule flagsticks fall right into place every time without twisting, sticking or sinking. Bonderite aluminum cups for maximum life and the most chip-resistant coating around. High-strength plastic cups molded with chemical-resistant polymers provide a brilliant, lasting finish. Meets all USGA regulations.

## Aluminum ST2000

6" tall 4 1/4 (10.8 cm) diameter. Manufactured with their new MagnaTech™ Proprietary Aluminum.

ST18333

## Hybrid ST2000

6" tall 4 1/4 (10.8 cm) diameter. The hybrid cup combines an aluminum base with plastic walls.

ST18222

## Plastic ST2000

6" tall 4 1/4 (10.8 cm) diameter molded with chemical-resistant polymers

ST18444

## Smart Fit Pro Ferrule

16 tapered flanges seat the ferrule and flagstick perfectly with the Smart-Fit Cup

ST26512



### Do It Yourself Laser Reflector

Full 360° visibility. High reflective, large surface area. Kit fits flag poles under 1" diameter. When ordering the kit please indicate the diameter of your flag poles. Easy to install on current flagsticks or flagpoles \* Set of 9

**BY3000-9**



### Placement Flags

- \* Slide up or down to indicate hole position. Remind players to "Please Repair Ball Marks" (English only).
- \* Made with DuPont SolarMax® Nylon.
- \* Set of 9

**1/2"**  
**ST05335** Red  
**ST05355** Yellow

**3/4"**  
**ST05337** Red  
**ST05357** Yellow



### Easy Mark

- \* Put a flagstick anywhere, without cutting a cup hole
- \* Versatile tap in anchor
- \* New EasyMark II is longer with wider top for more secure fit - same diameter as a cup

**ST37300** New EasyMark II - Ferruled flagsticks  
**ST26755** Non-ferruled flagsticks (2 pieces)



### Guard for Flag Poles

An economical and easy way to re-new and protect splintered, cracked, faded, scratched, or dirty poles. Quickly applies with heat gun and will last for years. Fits tournament and regulation poles. White or yellow

**BY3112** 250' Roll for 1/2" Pole  
**BY3143** 250' Roll for 3/4" Pole



### Aluminum Pro-Hole Cup

Pro Hole Cups are designed and finished to precise standards, resulting in a world class greens cup. Completed with locking ferrule system that ensures unnecessary premature wear of the flag pole ferrule.

This cup is made of durable heat treated aluminum alloy

**BY253AL**



### Aluminum Cups

These cups are die cast oversize, then machined down to precise dimensions to minimize wobble in the hole. The aluminum cups are anodized then powder coated a bright white for best corrosion protection. Meets all USGA requirements.

**BY252AL** Aluminum Greens Cup (4.25")

**BY250AL** Aluminum Green Cup (6")



### SpeedWrap Liners

SpeedWrap liners are thin, flat inserts that fit only in our pro hole cups. Fully customizable with a club logo or sponsor for increased revenue. The blank and specialized cup liners are in stock and ready for immediate shipping.

**BY253LCAN** Canada Liner

**BY253LPINK** Pink Liner

**BY253AL** Blank Liner

**BY253CUSTOM** Custom Liner



### Plastic Cups

Made of durable, chemical resistant polymer material and meets all USGA regulations. Perfect for putting greens.

**BY250PGA** PGA Greens Cup

Precision machined to exact PGA tolerance inside and out. The base is designed with three support pads to maintain a stable height.

**BY255PL** Plastic Greens Cup (4.25")

**BY250PL** Plastic Greens Cup (6")

**BY250PL/BZ** Plastic Cup with Bronze Insert (6")

Bronze bushing made of certified bearing bronze withstands abrasion and prevents sticking, extending the life of your cup.



BYTL1

BY207



### Hole-In Paint Tools

Easy to use guide to paint the top of the hole while protecting the grass around the upper edge and the cup from the spray of the paint.

- BYTL1** Aluminum Paint Tool
- BYCP1** Cup Protector\*
- BY207** Hole-In Paint Applicator

\* Cup protector available in every case of Hole-In-White paint. sold separately if required

### Hole-In Paint

Hole-In paint is a whitener specifically formulated to last a long time and is not harmful to the soil or turf. One spray can could yield approximately 80 holes. It makes the top of the hole bright and visible from afar, speeding up play time in the process. Approved by PGA, Champions, and the LPGA, use this tournament grade standard to upgrade your course. 12 oz each

- BYPT1** Hole-In Paint White Case of 12
- BYPT2** Hole-In Paint Pink Case of 6

### Cup Sleeve

Cup sleeves are used in the installation of artificial putting greens. Made from PVC plastic and machined for a perfect fit! The cup will sit 1/8" above the plastic when installed.

- BY259-4** 4" Cup Sleeve
- BY259-6** 6" Cup Sleeve

### Plastic Cup Covers

Cover the putting green holes with this easy to install and remove cover. Made of durable plastic, it withstands pressure and weight.

- BY262** 4 1/4" Cup Cover

### Aluminum Cup Setter

Cast aluminum cup setter consistently places cups at the correct depth, minimizing damage to the rims of aluminum cups and preventing ball interference.

- BY205** Cup Setter

### Curved Trimming Scissors

Superior quality scissors, constructed from forged Stainless Steel. Comes complete with a dedicated plastic carry wallet. The curved design makes it easier to neaten the edges of freshly cut holes.

- BY211**



### Cup Pullers

Powder coated white with a red rubber handle. Size: approx.

**BY210**

**Single Pronged Approx. 6"**

**BY206**

**Double Pronged Approx 8"**

**BY200**

**Three Pronged Approx. 24"**  
**Works only on 250AL cups**



### Shell Sharpener

Keeps shells sharp for easier cuts and precision cut hole edges. Works with scalloped or straight cutter styles - inside or outside.

**ST28400**



### Depth Gauge

Ensure consistent, accurate cuts

**ST28600**



### Hole Cutter Flanged Stop

Adjustable flanged stop ensures proper hole depth every time.

**BY217**



BY2

BY224

BY223



BY219



Scalloped Shell



Straight Shell

### Bayco Hole Cutters

Easy to use lever makes for a quick hole extraction. Foot Extraction is a classic hole cutter with shoe platforms on either side and a fixated handle. Heat treated cutting blades ensure a clean cut hole. Available as scalloped and straight blade with an inside edge (for sandy and USGA soil) or an outside edge (for push-up greens and native soil)

BY222	Lever Style Hole Cutter Scalloped Blade
BY223	Lever Style Hole Cutter Straight Blade
BY224	Foot Extraction Hole Cutter Straight Blade
BY225	Foot Extraction Hole Cutter Scalloped

BY219	Wide Hole Cutter for 6" wide cups
-------	-----------------------------------

### Bayco Replacement Blades

• Heat treated cutting blades ensure a clean cut hole. Available as scalloped and straight blade with an inside edge (for sandy and USGA soil) or an outside edge (for push-up greens and native soil)

BY220-IN	Inside Edge Scalloped Blade
BY220-OUT	Outside Edge Scalloped Blade
BY221-IN	Inside Straight Blade
BY221-OUT	Outside Straight Blade



### InstaFix Ballmark Repair Tool

New and improved ball mark repair tool. No moving parts, one solid piece of aluminum with six blades forces grass and roots into damaged areas. Cap Included  
Length: 36"

**BY227-36**

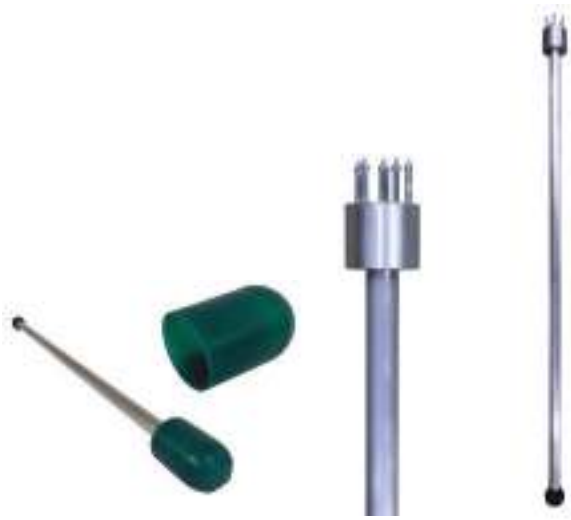

### Green Speedmeter

Made of extruded aluminum alloy with a V-shaped groove extending along its length and a milled base to reduce bounce as the ball makes contact with the green surface.  
Length: 36"

**BY240**



### Dew Whipping Pole

Removes dew and other light debris from greens. The tip (8') slides inside the handle (8') during storage and transportation

**BY280**

**Complete Unit**

**BY280-2S**

**Replacement Rod**



### Coco Fiber Drag Mat

Made of natural fiber that will not damage, burn, or bruise tender grass. The fibers offer superb broom action, making it perfect for top dressing and filling aerated holes. Complete with a tow bar and a chain for easy attachment.

**BY247-6X4**

**6' X 4'**



**WOULD YOU  
LIKE A DIVOT  
FREE COURSE  
NEXT YEAR?**



**WOULD YOU  
LIKE TO SAVE  
TIME & MONEY?**

# **THEN** YOU NEED **Multimat™**

*Supplied to protect the course prior to  
The Open Championships of 2003, 2006, 2011, 2014, 2019 & 2021,  
as well as the Irish Opens of 2012, 2015, 2017 & 2020*

- *The No.1 two sided durable plastic mat that lasts for many years*
- *Will not break when miss-hit, even when frozen to minus 20°C.*
- *Grippers on both sides restrict mat movement during shots.*
- *Recessed areas prevent ball movement, even on the steepest slopes.*
- *Double sided lightweight design with choice of 2 consistent playing surfaces.*
- *Double ended one piece plastic moulding means no parts to lose, replace or break.*
- *Compact and portable. Measures just 15.5" x 4.5".*

Scan in the  
QR code to see the  
**Multimat™**  
in action



# Multimat™

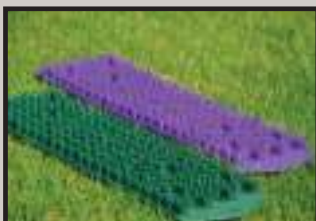

## THE BENEFITS

- ✗ No divots
- ✗ No additional ground maintenance
- ✗ No time wasting repairs
- ✗ No shoddy astroturf or carpet
- ✗ No parts to lose or break
- ✓ Innovative, cost effective solution
- ✓ An open course equals extra revenue
- ✓ Used at over 500 venues worldwide
- ✓ Lower course maintenance costs
- ✓ Easy to use for all levels of player
- ✓ Ideal pre-tournament course protection
- ✓ Promotes sustainable golf by saving time and money
- ✓ Ideal for personal use during COVID-19 restrictions

See our website for the latest prices and offers

Can be purchased individually or in bulk for resale

Call us today for a quotation

**Multimat™ IS RECOMMENDED FOR HEAVY PROLONGED USE THROUGHOUT THE WINTER MONTHS**

GREEN

FPG280-G

PURPLE

FPG280-P

Multimat is packed 60/box! There are savings to be had for ordering in box quantities! Ask your Sales Rep

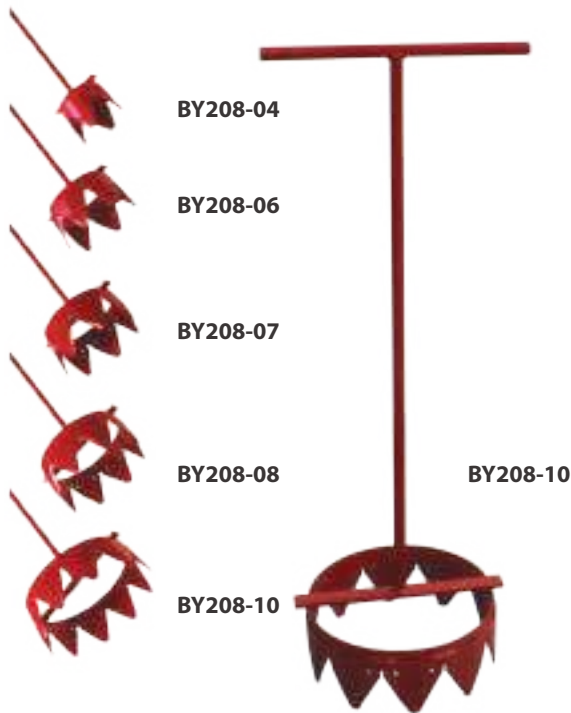

### Sprinkler Head Trimmers

Sprinkler heads can easily become lost on the course and lead to negative impacts on the functionality of the irrigation system. These trimmers are easy to use and leave a clean edge around the sprinklers.

<b>BY208-04</b>	<b>4" Diameter</b>
<b>BY208-06</b>	<b>6" Diameter</b>
<b>BY208-07</b>	<b>7" Diameter</b>
<b>BY208-08</b>	<b>8" Diameter</b>
<b>BY208-10</b>	<b>10" Diameter</b>



### E-Z Reacher

Aluminum shaft with stainless steel grabbers that open to a 4.5" width. Capable of lifting up to 6 lb and sensitive enough to pick up a dime.

<b>BY208-07</b>	<b>32" Handle</b>
<b>BY208-08</b>	<b>40" Handle</b>
<b>BY208-10</b>	<b>72" Handle</b>



### SOLO Back Pack Sprayer

Durable, dense polyethylene tank, easy to fill 4.25" opening, 28" wand, and chemically resistant seal. Capable of performing every spraying task.

<b>BY190</b>
--------------



BY130-24

### Non-Absorbant Roller Squeegee

A squeegee roller made of industrial grade stainless steel axle and efficient nonabsorbent rubber roller; effectively rolls collected water. Replacement heads available.

**Complete Kit**

**Head Only**

BY130-24	24" Width	BY130-24H
BY130-36	36" Width	BY130-36H
BY130-48	48" Width	BY130-48H



BY115AL

### Aluminum Landscaper

This aluminum landscape rake is used for ground raking, smoothing, leveling, spreading, seeding & leaf clean-up. The heavy duty brace is all one piece and is riveted to the rake head.

BY114AL	24" Width
BY115AL	36" Width
BY116AL	48" Width



BY131

### Plug Pusher

Light, heavy duty aluminum plug pusher will make cleaning up the golf course easy. It efficiently pushes plugs or moves and levels sand and loose material.

BY131
-------



### Levelawn Pro

Distributes application materials. Removes stones from soil, breaks up small clods of sand or loam. Smoothes soil for easy planting. Newtwo-piece, wooden handle for ease of shipping

ST29310	30" (76cm) Levelawn
ST29320	36" (91cm) Levelawn

## COVERTECH

### CoverTech Golf Green Solutions

The Product Choice For The Past 15 Years

- \* Cover solution designed exclusively for Canadian Golf Courses
- \* Made of tough woven non-coated polyethylene material
- \* Covers protect turf from frost and ice damage.
- \* Ice Shield is UV treated to withstand the elements
- \* Recommended for fall, winter, and spring to protect the turf and accelerate germination
- \* Promotes quicker golf course openings by 2-3 weeks and earlier root establishment
- \* Easy installation
- \* Custom sizes available
- \* Product shipped with pegs and storage bags designed for re-use
- \* Manufactured in Canada





### In-Ground Trash Cans

- \* 98% galvanized steel w/ protective coating and paintable lid
- \* Remove unsightly trash cans and beautify your property
- \* No windblown debris
- \* No animals
- \* No odour
- \* Hands free lid access



Our in-ground trash cans eliminate unsightly garbage containers and messy windblown debris across your property.

You get a lifetime of satisfaction because these are the most durable garbage container systems available. No plastic parts to break or wear out. Spot welding and industrial strength pins / bolts. Construction is over 98% galvanized steel.

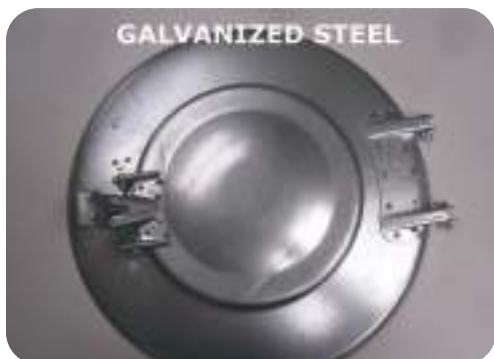

Lids have an epoxy bonded coating, which provides superior protection and the ability to be painted.

Put your foot on the lid to pop open. Clean-up is non-existent, animals have no access, and foul odors are eliminated.



<b>320-A-SD</b>	<b>20 Gallon Complete w/2 pc lid</b>
<b>325-A-SD</b>	<b>25 Gallon Complete w/2 pc lid</b>
<b>320-B-SD</b>	<b>20 Gallon Complete w/1 pc lid</b>
<b>325-B-SD</b>	<b>25 Gallon Complete w/1 pc lid</b>
<b>1</b>	<b>Lid Powdercoating (8+)</b>

## QUICK-INSTALL METHOD 1

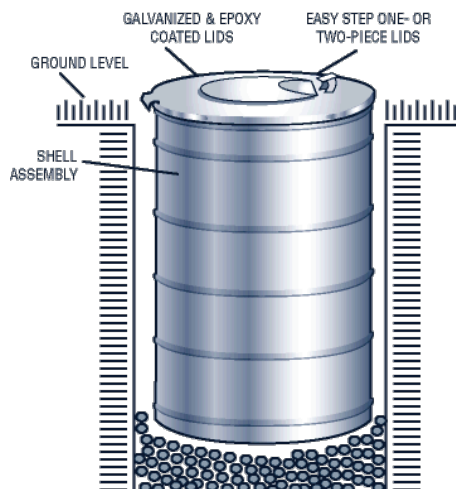

## HEAVY-DUTY INSTALL METHOD 2

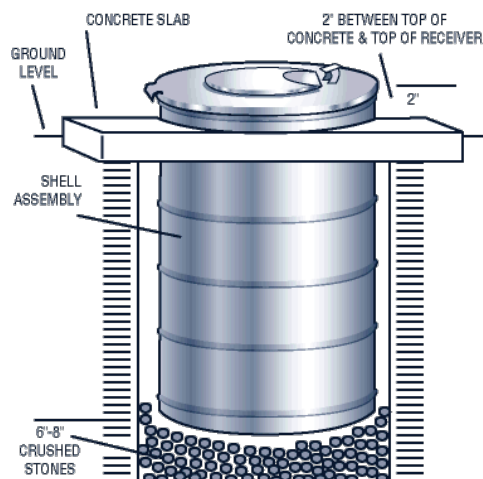

## Installation Made Easy

Locate your Underground Receiver on the highest available ground where there is no abnormal water drainage, such as exists near a downspout. A place near the back door will give quick, easy access in all kinds of weather.

Dig or auger a hole 6" to 8" deeper than the unit and at least 4" wider than the Shell diameter if the hole is dug. This makes it easier to tamp the earth around the Shell. Fill the extra depth with coarse gravel or stone to form a base for good drainage.

Set the Receiver in the hole with the Step pointing in the most convenient position for opening the Lid. Tamp the earth tightly against the Shell and slope the earth up to the top edge of the Shell. Be sure to keep the Shell round (check by placing the Insert-Can in the Shell—it should slip in easily). Also be sure the hinge works freely.

The handiest tools for digging the hole are post-hole diggers, hand or gas augers. Multiple cans are easily augered with a small machine-mounted-auger-available on a rental basis at many hardware stores and contractors.

It is good proactive to allow the top of the Receiver to be at least 2" above ground level. This elevation will drain water away from the Receiver in all directions.

Locate your Underground Receiver on the highest available ground where there is no abnormal water drainage, such as exists near a downspout. A place near the back door will give quick, easy access in all kinds of weather.

Dig or auger a hole 6" to 8" deeper than the unit and at least 4" wider than the Shell diameter if the hole is dug. This makes it easier to tamp the earth around the Shell.

Fill the extra depth with coarse gravel or stone to form a base for good drainage. Set the Receiver in the hole with the Step pointing in the most convenient position for opening the Lid. Make a level, wooden form, staked into its permanent position, to create a concrete slab around the Receiver(s).

Place the Shell inside the hole so that it will be 1" above the top of poured concrete. Tamp the earth tightly against the Shell. Be sure to keep the Shell round (check by placing the Insert-Can in the Shell—it should slip in easily).

Pour the concrete in the form and trowel a gradual slope away from the form to the top of the Shell receiver. This will rain the water away from the receiver. It may be necessary to work the concrete away from the hinge. **BE SURE THE HINGE WORKS FREELY BEFORE THE CONCRETE SETS UP.**

Multiple cans are easily placed in a single pad or patio. It is a good practice to install the Slab higher than the ground level to keep water out of the receiver.

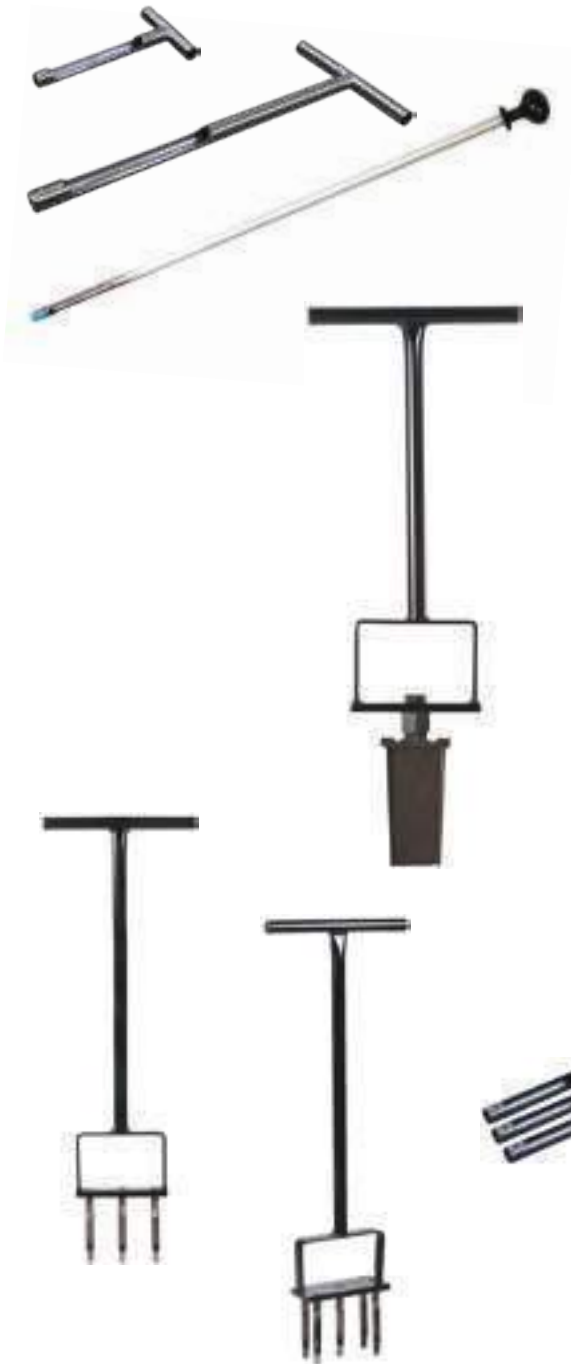

### Soil Samplers

Soil samplers allow core samples to be taken for evaluation of soil composition and root growth or for subsequent soil analysis. It also helps determine the need for aeration and to select the proper fertilizer for root development

**BY235-8** **8" Soil Sampler**

One piece rugged stainless steel pipe.

**BY235** **20" Soil Sampler**

One piece rugged stainless steel pipe.

**BY237** **27" Greens Probe Soil Sampler**

Less intrusive, one piece rugged stainless steel pipe. Complete with a rubber handle for added comfort.

### Greens Section Soil Sampler

This spade-like greens section soil sampler is tapered to give a clean cut and minimize surface disruption. The blade is then easily removed to examine the profile of the sample.

**BY238**

### Hand Operated Aerators

Made of heavy duty steel, these aerators are easy to use on those small and hard to reach spots on the greens that need immediate attention.

**BY236** **Hand Operated 3-Pronged Aerifier**

**BY239** **Hand Operated 5-Pronged Aerifier**

**BY236-1** **Replacement Steel Tines**

Fits our aerifiers. Sold in sets of three. Complete with holding pins.

### Why aeration is important?

Aeration is an essential practice that improves the long-term health and playability of golf courses. By using hollow tines to extract plugs, you can:

- Ensure longevity of your course
- Alleviate compaction
- Remove layering

### Long lasting benefits of aeration:

The following benefits can be observed when aeration is done seasonally and correctly:

**Improves Water Infiltration**

**Oxygenates the Soil**

**Removes Thatch**

**Encourages Root Growth**

**Stimulates Microbial Activity**

**Promotes Recovery from Stress**





"CADDIE TO THE GOLF INDUSTRY"

### TERMS OF SALE

All prices are subject to change without notice.  
All prices are FOB our Mississauga warehouse.  
Prices do not include GST/HST which will be added to the invoiced product and shown separately.  
(GST# 841796428RT0001)

Minimum order is \$25.00.  
Orders under \$25.00 may be assessed a \$10.00 surcharge.

### CREDIT TERMS

Established credit accounts: Net 30 days for approved accounts in good standing.  
Interest charges are 2% per month (24% per annum) on overdue accounts.

New accounts: Prepaid with check or credit card.

Credit Cards Accepted: Visa, AMEX and MasterCard.  
Credit card orders will be charged the day the shipment leaves our facility.

### SHIPMENT POLICY

Unless otherwise requested, orders will be shipped via our choice of carrier.  
Shipping charges are approximately 5% of the order subtotal, with a \$10 per order minimum.

### NOTES:

\_\_\_\_\_

\_\_\_\_\_

\_\_\_\_\_

\_\_\_\_\_

\_\_\_\_\_

### DAMAGE CLAIMS

If your shipment arrives clearly damaged, make note of the damage on the receipt that the courier or other delivery party requires you to sign.  
If there are damages to the contents, report these to us within 24 hours, and provide a copy of the proof of delivery indicating your receipt of a damaged shipment.

### DISCREPANCIES

Your complete satisfaction is our goal. Should there be an error with your order we will work to correct it immediately. However, claims must be made within 7 days of receipt, and Golf Supply House is not responsible for claims made after that time.

### RETURNS

Our shipping department will not accept returned goods without prior authorization, which is provided by a Golf Supply House representative.

Authorization may be given within 7 days of your receipt of goods if:

- Goods were shipped in error
- We duplicated a shipment
- Goods are defective

Returns for reasons other than the above:

- Are subject to a 20% restocking fee
- Must be shipped freight prepaid by the customer
- Also require a return authorization number

The following items may only be returned if defective, within 7 days of receipt:

- Special ordered product
- Decorated product
- Closeout and discontinued product

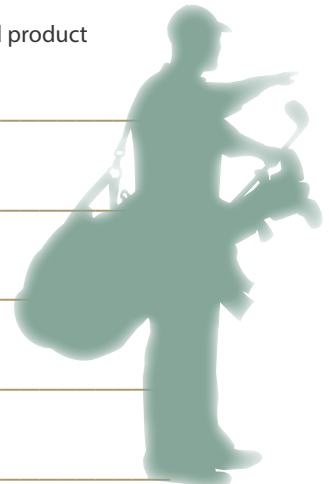

# SALES REPRESENTATIVES

Sales Rep	E-Mail	Phone	Area
Nathan Brooks	nathan@gshcanada.com	(289) 835-7518	GTA
Brendan Garvey	brendang@gshcanada.com	(800) 268-7934 ext 125	Ontario, Atlantic
Michael Hand	mike@gshcanada.com	(289) 293-1006	BC, Manitoba, Sask
Michael Huynh	michaelh@gshcanada.com	(800) 268-7934 ext 126	Ottawa, Quebec, Atlantic
Bruce Paterson	bruce@gshcanada.com	(519) 878-1973	SW Ontario
Taylor Ross	taylor@gshcanada.com	(705) 719-3423	Alberta
Quebec Distributor			
Jean-Guy Poirier Golf	order@jgpgolf.com	(800) 363-2060	Quebec

## OFFICE

British Columbia Office		
Rod Halsall	General Manager	rod@gshcanada.com
Candice Chai	Web Graphics/Marketing	candice@gshcanada.com
Ontario Office		
Tim Middleton	National Sales Manager	timm@gshcanada.com
Mansoor Elahi	Controller	mansoor@gshcanada.com
Derek Russell	Turf, Netting & Special Projects Coordinator	derek@gshcanada.com
Custom, Art and Graphics Department		
Sharon Ryan	Custom Order Coordinator	sharon@gshcanada.com

### ONTARIO

#300-36 Morrow Road

Barrie, ON L4N 3V8

### BRITISH COLUMBIA

#111 - 1776 Broadway Street

Port Coquitlam, BC V3C 2M8

**TOLL FREE** 800-268-7934

sales@gshcanada.com

**WEB** [www.shop.gshcanada.com](http://www.shop.gshcanada.com)

**TWITTER & INSTAGRAM** @golfsupplyhouse

**LINKED IN** <http://www.linkedin.com/company/golf-supply-house>